



# DOMINO/DEVICE+ CATALOG

OneLab 1.20

Waters™

The pace of innovation in current day biological research demands the highest levels of reproducibility and traceability.

Waters Automation has developed an intelligent cloud-based software environment called **OneLab** within which experiments can be intuitively designed, repeatably executed, and tracked through a rapidly evolving ecosystem of connected devices, Dominos and accessories.

With the constant addition of new capabilities, accessories and consumables in OneLab, this regularly updated catalog provides a complete list of all of the consumables that have been made compatible with our Dominos and Devices.



**Dominos** are machine-readable consumable holders that create the interface between a variety of different consumable types and the Andrew+ pipetting robot to enable seamless automation of many different laboratory workflows.

Equipped with QR codes housing critical consumable information and ARUCO codes for spatial positioning, Dominos are an indispensable part of any Andrew+ automation configuration.



**Device+** units are active devices that elevate both manual and fully automated workflows on the Andrew+ instrument by adding specific functionality while being fully connected to OneLab through WiFi or Ethernet. Just like Dominos, they are equipped with QR codes housing critical consumable information and ARUCO codes for spatial positioning. Use **Device+** units to add the following functionality to your OneLab methods: Shaking, Flow-Through Extractions, Magnetic Bead Separations, Heat-Shaking and Heating/Cooling.

Use the following symbols on each consumable page to identify their compatibility with Waters Connected Pipettes when used with the Andrew+ robot



Compatible



Incompatible



« on-the-fly » :  
Only on-the-fly dispensing is possible

**1 500**

Numeric value :  
The minimal volume in  $\mu\text{L}$  that the consumable must contain to allow the use of the pipette in OneLab

Any consumable with the Microplate Gripper Compatibility icon can be moved between compatible positions by the Andrew+ robot



Want to buy a Domino, Device+ or Waters Consumable? Use the active links throughout this catalog to go to their page on our e-shop

[SEE THIS DOMINO ON OUR E-SHOP](#)

If you need any assistance:

[Visit our Help Center](#)

[Contact our Sales Specialists](#)

# INDEX

## DOMINOS

4

## TIP DOMINOS

5

## STANDARD DOMINOS

9

### FOR PLATES AND RESERVOIRS

Microplate Domino	10
Deepwell Microplate Domino	11
Storage Plate Domino	81
96-PCR Plate Domino	135
PCR Cartridge Domino	171
Wes and Jess Plate Domino	185
Non-ANSI Plate Domino	187
Landing pad microplate domino	189
100-well HoneyComb Plate Domino	191
Metallic OEM Plate Domino	193
Tilted Microplate Domino	195
Long Edge Tilt Deepwell Domino	197
8-Channel Pipette Reservoir Domino	207
	210

### FOR TUBES AND VIALS

24-Well Photoredox Block Domino	212
0.5-0.6mL Microtube Domino	213
Microtube Domino	215
5mL Microtube Domino	220
5mL Round Bottom Tube Domino	238
5mL Cryotube Domino	244
Labeled Test Tube Domino	250
Conical Bottom Tube Domino	252
2mL Cryogenic Storage Vial Domino	257
13mL Tube Domino	259
14mL Round Bottom Test Tube Domino	261
15mL Conical Centrifuge Tube Domino	265
20mL C15 B Glass Vial Domino	268
FLAVER 30mL Glass Vial Domino	275
FLAVER 60mL Glass Vial Domino	277
50mL Conical Centrifuge Tube Domino	280
50mL PrepTube Domino	282
4mL Autosampler Vial Domino	292
SCIEX Universal Vial Domino	294
SCIEX 6X6 TRAY DOMINO	299
5mL Serum Vial Domino	301
8mL Sample Vial Domino	303
10mL Serum Vial Domino	305
20mL Serum Vial Domino	309
20mL Reaction Vial Domino	311
22mL Glass Vial Domino	313
29mL Glass Culture Tube Domino	318
Ø9mm Glass Vial Domino	321
Ø12mm Vial Domino	323
Ø12.5mm Tube and Vial Domino	326
Ø13mm Tube Domino	330
Ø16mm Vial Domino	333
16x90mm Glass Tube Domino	337
Ø16mm 30x Tube Domino	339
Ø19mm Vial Domino	346
Ø21mm Vial Domino	351
Ø23mm Headspace Vial Domino	354
Ø27mm Vial Domino	356
Ø28mm Test Tube Domino	358
Tilted Vial Domino	360
	362

### FOR BOTTLES

Ø46mm Bottle Domino	364
Ø51mm Bottle Domino	365
Ø55mm 10x Bottle Domino	367
Nalgene™ 15mL Bottle Domino	369
Nalgene™ 60mL Bottle Domino	371
100mL Bottle Magnetic Stirrer Domino	374
Nalgene™ 125mL Bottle Domino	376
125mL Storage Bottle Domino	378
125mL Square Bottle Domino	380
Nalgene™ 175mL Bottle Domino	382
250mL DURAN bottle Domino	384
500mL Round Bottle Domino	386
Conical Bottom 500mL Tube Domino	389
	392

### FOR OTHER CONSUMABLE TYPES

Square Cuvette Domino	394
NucleoBond Xtra Midi Column Domino	395
	400

## COOLED DOMINOS

402

### FOR PLATES AND RESERVOIRS

96-PCR Plate Cooled Domino	403
384-PCR Plate Cooled Domino	404
8-Channel Reservoir Cooled Domino	407
	410

### FOR TUBES AND VIALS

0.5mL Microtube Cooled Domino	412
1.5mL Microtube Cooled Domino	413
2mL Microtube Cooled Domino	415
15mL Tube Cooled Domino	419
50mL Tube Cooled Domino	421
	423

## RACK DOMINOS

428

Collection Labware Rack Domino	430
Racked Tubes Domino	448
0.2mL MICROTUBE RACK DOMINO BUNDLE	453
1.2mL Microtube Rack Domino	455
BRAND® 1.2mL Microtube Rack Domino	457
2mL Cryotube Rack Domino	459
2mL HPLC Vial Rack Domino	462
Vials w/ 24x Rack Domino	482
Culture Tube w/ 48x Rack Domino	485
15mL Tube in 15x Rack Domino	487
60x 15mL Centrifuge Tube Rack Domino	489
50mL Tube in 55x Rack Domino	493
250mL Bottle in 18x Rack Domino	495

## DEVICE+

497

Microplate Shaker+	498
Tube Shaker+ w/ 12x75mm Tube Adaptor	538
Tube Shaker+ w/ 16x90mm Tube Adaptor	540
Tube Shaker+ w/ 5mL Tube Adaptor	544
Tube Shaker+ With Tilted Vial Adaptor	546
Tube Shaker+ w/40mL Tube Adaptor	548
Microplate Peltier+	550
96-PCR Peltier+	557
96-PCR Magnet+	568
Deepwell Magnet+	572
50mL Tube Magnet+	574
Heater-Shaker+	589
Extraction+	619



# DOMINOS



**TIP DOMINOS**

Ordering product number

**186009612**

OneLab reference: [218.1101]

## TIP INSERTION SYSTEM DOMINO



The Tip Insertion System Domino is a versatile system capable of holding a removable rack of 96x Sartorius OptiFit tips for volumes ranging from 0.2µL-1200µL in both filtered and non-filtered formats. Its force-dispensing design enables even tip insertion across all channels of 8-channel pipettes. All OptiFit tip trays are color-coded for easy matching with a corresponding, color-coded Waters Connected Pipette.

[SEE THIS DOMINO  
ON OUR E-SHOP](#)



**Manufacturer:**  
Sartorius

**Part number:**  
Variable

### 1-channel pipettes

●	●	●	●	●	●
10µL	120µL	300µL	1000µL	5mL	10mL
✓	✓	✓	✓	✗	✗

### 8-channel pipettes

●	●	●	●
10µL	120µL	300µL	1200µL
✓	✓	✓	✓

## IMPORTANT

Sartorius Optifit Tips are supplied in the following packaging types:

- Purity certified single tray racks
- Purity certified refill packs
- Refill towers
- FlexiBulk® boxes

5mL and 10mL Tips are NOT supported on the Tip Insertion System Domino



Ordering product number

**186009599**

OneLab reference: [218.1252]

## 5ML TIP RACK HOLDER DOMINO



The 5mL Tip Rack Holder Domino is designed to hold rack inserts of 50x non-filtered and filtered Sartorius OptiFit 5mL tips.

[SEE THIS DOMINO  
ON OUR E-SHOP](#)



**Manufacturer:**  
Sartorius

**Part number:**  
Variable

### 1-channel pipettes

●	●	●	●	●	●
10 $\mu$ L	120 $\mu$ L	300 $\mu$ L	1000 $\mu$ L	5mL	10mL
✗	✗	✗	✗	✓	✗

### 8-channel pipettes

●	●	●	●
10 $\mu$ L	120 $\mu$ L	300 $\mu$ L	1200 $\mu$ L
✗	✗	✗	✗

## IMPORTANT

Placing 5mL OptiFit tips on the 5mL Tip Rack Holder Domino requires the green, 50x rack insert sold only with Item No. 780304 from Sartorius (5mL OptiFit Racked Pipette Tips).

Ordering product number

**186010098**

OneLab reference: [218.1202]

# 10ML TIP RACK HOLDER DOMINO



The 10mL Tip Rack Holder Domino is designed to hold rack inserts of 35x non-filtered Sartorius OptiFit 10mL tips.

[SEE THIS DOMINO  
ON OUR E-SHOP](#)



**Manufacturer:**  
Sartorius

**Part number:**  
Variable

## 1-channel pipettes

10µL	120µL	300µL	1000µL	5mL	10mL

## 8-channel pipettes

10µL	120µL	300µL	1200µL

## IMPORTANT

Placing 10mL OptiFit tips on the 10mL Tip Rack Holder Domino requires the red, 35x rack insert **sold only with Item No. LH-780314 from Sartorius (10mL OptiFit Racked Pipette Tips).**



**STANDARD DOMINOS**

**FOR PLATES  
AND RESERVOIRS**

Ordering product number

**186009600**

OneLab reference: [218.2002]

## MICROPLATE DOMINO



The Microplate Domino is designed to hold a growing array of various skirted microplates.

[SEE THIS DOMINO  
ON OUR E-SHOP](#)

# 96-well micro photoredox block assembly



**Manufacturer:**  
Analytical Sales  
& Services, Inc.

**Part number:**  
10421-CASE

1-channel pipettes					
10 $\mu$ L	120 $\mu$ L	300 $\mu$ L	1000 $\mu$ L	5mL	10mL
✓	20	80	100	🧪	🧪

  

8-channel pipettes			
10 $\mu$ L	120 $\mu$ L	300 $\mu$ L	1200 $\mu$ L
✓	20	80	90



**MICROPLATE DOMINO**  
PN: 186009600

# ACC, Pyroclear<sup>®</sup> Pyroplate<sup>®</sup> 96-well microplate

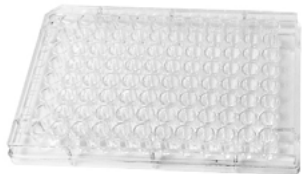

**Manufacturer:**  
Associates of Cape  
Cod, Inc.

**Part number:**  
CA961-50



1-channel pipettes					
10 $\mu$ L	120 $\mu$ L	300 $\mu$ L	1000 $\mu$ L	5mL	10mL
✓	✓	✓	✓	⚠	⚠

8-channel pipettes			
10 $\mu$ L	120 $\mu$ L	300 $\mu$ L	1200 $\mu$ L
✓	✓	✓	✓



MICROPLATE DOMINO  
PN: 186009600

# ArcticWhite, 7 mL 12-column low-profile reservoir



**Manufacturer:**  
ArcticWhite LLC

**Part number:**  
AWLS-S30028

1-channel pipettes					
10 $\mu$ L	120 $\mu$ L	300 $\mu$ L	1000 $\mu$ L	5mL	10mL
✓	✓	✓	✓	✓	✓

8-channel pipettes			
10 $\mu$ L	120 $\mu$ L	300 $\mu$ L	1200 $\mu$ L
✓	✓	✓	✓



MICROPLATE DOMINO  
PN: 186009600

# Armadillo 384-well PCR plate, red



**Manufacturer:**  
Thermo Scientific

**Part number:**  
AB3384R

1-channel pipettes					
10 $\mu$ L	120 $\mu$ L	300 $\mu$ L	1000 $\mu$ L	5mL	10mL
✓	✓	✓	✓	⚠	⚠

8-channel pipettes			
10 $\mu$ L	120 $\mu$ L	300 $\mu$ L	1200 $\mu$ L
✓	✓	✓	<b>10</b>



**MICROPLATE DOMINO**  
PN: 186009600

# Axygen® 500 µL 96-round deep well V-bottom plate



**Manufacturer:**  
Corning Inc.

**Part number:**  
P-96-450V-C-S

1-channel pipettes					
10µL	120µL	300µL	1000µL	5mL	10mL
✓	✓	✓	✓	⚠	⚠

8-channel pipettes			
10µL	120µL	300µL	1200µL
✓	✓	✓	✓



**MICROPLATE DOMINO**  
PN: 186009600



# CELLSTAR® 6-well cell culture plate



**Manufacturer:**  
Greiner Bio-One

**Part number:**  
657160

1-channel pipettes					
10µL	120µL	300µL	1000µL	5mL	10mL
✓	✓	✓	✓	✓	✓

  

8-channel pipettes			
10µL	120µL	300µL	1200µL
✓	✓	✓	✓



MICROPLATE DOMINO  
PN: 186009600

# CELLSTAR® 24-well cell culture plate

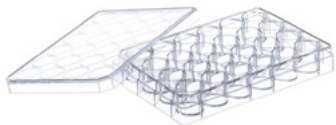

**Manufacturer:**  
Greiner Bio-One

**Part number:**  
662160

1-channel pipettes					
10µL	120µL	300µL	1000µL	5mL	10mL
✓	✓	✓	✓	✓	✓

  

8-channel pipettes			
10µL	120µL	300µL	1200µL
✗	✗	✗	✗



MICROPLATE DOMINO  
PN: 186009600

# CELLSTAR® 96-well clear F-bottom cell culture microplate

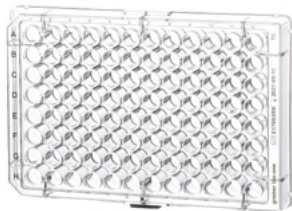

**Manufacturer:**  
Greiner Bio-One

**Part number:**  
655180



Compatible with  
Microplate  
Gripper

## 1-channel pipettes

10µL	120µL	300µL	1000µL	5mL	10mL
✓	✓	✓	✓	⚠	⚠

## 8-channel pipettes

10µL	120µL	300µL	1200µL
✓	✓	✓	✓



MICROPLATE DOMINO  
PN: 186009600

# Clear C-Shaped Immuno Nonsterile 96-Well Plates



**Manufacturer:**  
Thermo Scientific

**Part number:**  
446612

1-channel pipettes					
10 $\mu$ L	120 $\mu$ L	300 $\mu$ L	1000 $\mu$ L	5mL	10mL
✓	✓	✓	✓	⚠	⚠

8-channel pipettes			
10 $\mu$ L	120 $\mu$ L	300 $\mu$ L	1200 $\mu$ L
✓	✓	✓	✓



**MICROPLATE DOMINO**  
PN: 186009600

# Clear Flat-Bottom Immuno Nonsterile 96-well plate



**Manufacturer:**  
Thermo Scientific

**Part number:**  
439454

1-channel pipettes					
10 $\mu$ L	120 $\mu$ L	300 $\mu$ L	1000 $\mu$ L	5mL	10mL
✓	✓	✓	✓	⚠	⚠

8-channel pipettes			
10 $\mu$ L	120 $\mu$ L	300 $\mu$ L	1200 $\mu$ L
✓	✓	✓	✓



**MICROPLATE DOMINO**  
PN: 186009600

# Clear Flat-Bottom Immuno Nonsterile 96-well plate 2HB



**Manufacturer:**  
Thermo Scientific

**Part number:**  
3455

1-channel pipettes					
10 $\mu$ L	120 $\mu$ L	300 $\mu$ L	1000 $\mu$ L	5mL	10mL
✓	✓	✓	✓	⚠	⚠

  

8-channel pipettes			
10 $\mu$ L	120 $\mu$ L	300 $\mu$ L	1200 $\mu$ L
✓	✓	✓	✓



**MICROPLATE DOMINO**  
PN: 186009600

# Clickbio, VBLOK 200 mL V-bottom reservoir

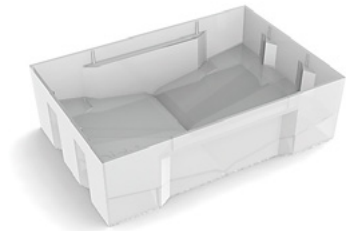

**Manufacturer:**  
ClickBio

**Part number:**  
CBVBLOK200-1

## 1-channel pipettes

10 $\mu$ L	120 $\mu$ L	300 $\mu$ L	1000 $\mu$ L	5mL	10mL
✓	✓	✓	✓	✓	✓

## 8-channel pipettes

10 $\mu$ L	120 $\mu$ L	300 $\mu$ L	1200 $\mu$ L
✓	✓	✓	✓



**MICROPLATE DOMINO**  
PN: 186009600

# Corning® 96-well Flat Bottom Polystyrene NBS Microplate



**Manufacturer:**  
Corning Inc.

**Part number:**  
3651

1-channel pipettes					
10µL	120µL	300µL	1000µL	5mL	10mL
✓	✓	✓	✓	⚠	⚠

8-channel pipettes			
10µL	120µL	300µL	1200µL
✓	✓	✓	✓



**MICROPLATE DOMINO**  
PN: 186009600



# Corning® 96-Well TC-Treated Microplate



**Manufacturer:**  
Corning Inc.

**Part number:**  
3585

1-channel pipettes					
10µL	120µL	300µL	1000µL	5mL	10mL
✓	✓	✓	✓	⚠	⚠

8-channel pipettes			
10µL	120µL	300µL	1200µL
✓	✓	✓	✓



**MICROPLATE DOMINO**  
PN: 186009600

# Corning® 96-well U-bottom TC-treated microplate



**Manufacturer:**  
Corning Inc.

**Part number:**  
3799

1-channel pipettes					
10µL	120µL	300µL	1000µL	5mL	10mL
✓	✓	✓	✓	✓	✓

  

8-channel pipettes			
10µL	120µL	300µL	1200µL
✓	✓	✓	✓



**MICROPLATE DOMINO**  
PN: 186009600

# Corning® 384-Well Clear Round Bottom Microplate

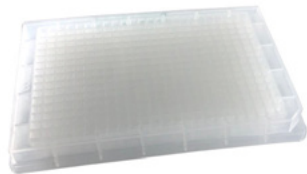

**Manufacturer:**  
Corning Inc.

**Part number:**  
3656



1-channel pipettes					
10µL	120µL	300µL	1000µL	5mL	10mL
✓	✓	✓	✓	⚠	⚠

8-channel pipettes			
10µL	120µL	300µL	1200µL
✓	✓	✓	✓



**MICROPLATE DOMINO**  
PN: 186009600

# Corning® CellBIND® 360 µL 96-well clear bottom black microplate



**Manufacturer:**  
Corning Inc.

**Part number:**  
3340

1-channel pipettes					
10µL	120µL	300µL	1000µL	5mL	10mL
✓	✓	✓	✓	⚠	⚠

8-channel pipettes			
10µL	120µL	300µL	1200µL
✓	✓	✓	✓



**MICROPLATE DOMINO**  
PN: 186009600

# Corning® CellBIND® 360 µL 96-well clear bottom black microplate



**Manufacturer:**  
Corning Inc.

**Part number:**  
3340

1-channel pipettes					
10µL	120µL	300µL	1000µL	5mL	10mL
✓	✓	✓	✓	⚠	⚠

  

8-channel pipettes			
10µL	120µL	300µL	1200µL
✓	✓	✓	✓



**MICROPLATE DOMINO**  
PN: 186009600

# Corning® low-volume 384-well clear F-bottom black microplate

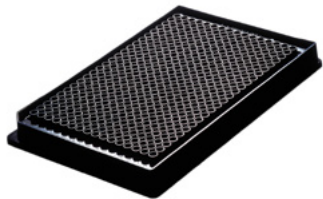

**Manufacturer:**  
Corning Inc.

**Part number:**  
3542

1-channel pipettes					
10 $\mu$ L	120 $\mu$ L	300 $\mu$ L	1000 $\mu$ L	5mL	10mL
✓	✓	✓	🚫	🚫	🚫

  

8-channel pipettes			
10 $\mu$ L	120 $\mu$ L	300 $\mu$ L	1200 $\mu$ L
✓	✓	✓	✓



**MICROPLATE DOMINO**  
PN: 186009600

# Corning® low-volume 384-well white F-bottom microplate

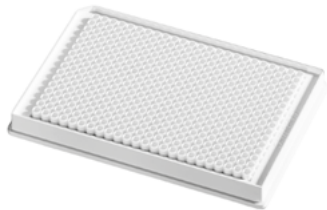

**Manufacturer:**  
Corning Inc.

**Part number:**  
3826

1-channel pipettes					
10µL	120µL	300µL	1000µL	5mL	10mL
✓	✓	✓	✓	⚠	⚠

8-channel pipettes			
10µL	120µL	300µL	1200µL
✓	✓	✓	✓



**MICROPLATE DOMINO**  
PN: 186009600

# Costar® 48-well cell culture plate



**Manufacturer:**  
Corning Inc.

**Part number:**  
3548

1-channel pipettes					
10 $\mu$ L	120 $\mu$ L	300 $\mu$ L	1000 $\mu$ L	5mL	10mL
✓	✓	✓	✓	✓	✓

8-channel pipettes			
10 $\mu$ L	120 $\mu$ L	300 $\mu$ L	1200 $\mu$ L
✗	✗	✗	✗



**MICROPLATE DOMINO**  
PN: 186009600



# DURAN® 10 mL clear glass laboratory bottle in 2x3 position holder



**Manufacturer:**  
DWK Life Sciences

**Part number:**  
218010851

1-channel pipettes					
10µL	120µL	300µL	1000µL	5mL	10mL
✓	✓	✓	✓	✓	✓

8-channel pipettes			
10µL	120µL	300µL	1200µL
✗	✗	✗	✗



**MICROPLATE DOMINO**  
PN: 186009600

# DURAN® 25 mL clear glass laboratory bottle in 2x3 position holder



**Manufacturer:**  
DWK Life Sciences

**Part number:**  
218011404

1-channel pipettes					
10µL	120µL	300µL	1000µL	5mL	10mL
✓	✓	✓	✓	✓	✓

8-channel pipettes			
10µL	120µL	300µL	1200µL
✗	✗	✗	✗



**MICROPLATE DOMINO**  
PN: 186009600

# Eppendorf twin.tec® 96-well skirted LoBind® PCR plate



**Manufacturer:**  
Eppendorf

**Part number:**  
0030129555



1-channel pipettes					
10µL	120µL	300µL	1000µL	5mL	10mL
✓	✓	✓	✓	⚠	⚠

  

8-channel pipettes			
10µL	120µL	300µL	1200µL
✓	✓	✓	✓



**MICROPLATE DOMINO**  
PN: 186009600

# FrameStar® 0.1 mL 96-well skirted low profile PCR plate, clear wells

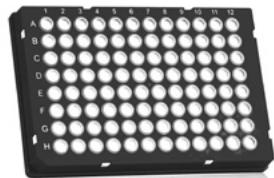

**Manufacturer:**  
Azenta Life Sciences

**Part number:**  
4ti-0960/RIG



## 1-channel pipettes

10µL	120µL	300µL	1000µL	5mL	10mL
✓	✓	✓	✓	⚠	⚠

## 8-channel pipettes

10µL	120µL	300µL	1200µL
✓	✓	✓	✓



**MICROPLATE DOMINO**  
PN: 186009600

# FrameStar® break-a-way PCR plate in 96x FrameStrip® adapter

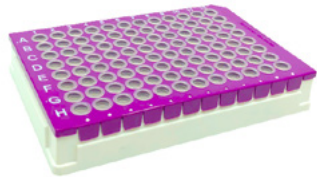

**Manufacturer:**  
Azenta Life Sciences

**Part number:**  
4ti-1000/P

1-channel pipettes					
10µL	120µL	300µL	1000µL	5mL	10mL
✓	✓	✓	✓	✗	✗

  

8-channel pipettes			
10µL	120µL	300µL	1200µL
✓	✓	✓	✓



**MICROPLATE DOMINO**  
PN: 186009600

# FrameStrip® 8-well PCR tube strip in 96x FrameStrip® adapter

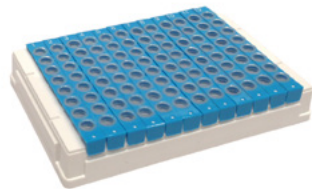

**Manufacturer:**  
Azenta Life Sciences

**Part number:**  
4ti-0786/B

1-channel pipettes					
10µL	120µL	300µL	1000µL	5mL	10mL
✓	✓	✓	✓	⚠	⚠

8-channel pipettes			
10µL	120µL	300µL	1200µL
✓	✓	✓	✓



**MICROPLATE DOMINO**  
PN: 186009600

# Greiner, 96-well PP U-bottom clear microplate



**Manufacturer:**  
Greiner Bio-One

**Part number:**  
650261

1-channel pipettes					
10 $\mu$ L	120 $\mu$ L	300 $\mu$ L	1000 $\mu$ L	5mL	10mL
✓	✓	✓	✓	✓	✓

  

8-channel pipettes			
10 $\mu$ L	120 $\mu$ L	300 $\mu$ L	1200 $\mu$ L
✓	✓	✓	✓



**MICROPLATE DOMINO**  
PN: 186009600

# Greiner, 96-well PP V-bottom clear microplate

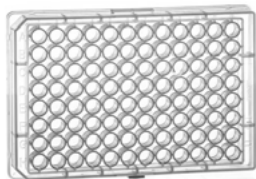

**Manufacturer:**  
Greiner Bio-One

**Part number:**  
651201

1-channel pipettes					
10 $\mu$ L	120 $\mu$ L	300 $\mu$ L	1000 $\mu$ L	5mL	10mL
✓	✓	✓	✓	⚠	⚠

8-channel pipettes			
10 $\mu$ L	120 $\mu$ L	300 $\mu$ L	1200 $\mu$ L
✓	✓	✓	✓



**MICROPLATE DOMINO**  
PN: 186009600



# Greiner, 96-well PS F-bottom clear microplate



**Manufacturer:**  
Greiner Bio-One

**Part number:**  
655101



## 1-channel pipettes

10 $\mu$ L	120 $\mu$ L	300 $\mu$ L	1000 $\mu$ L	5mL	10mL
✓	✓	✓	✓	✗	✗

## 8-channel pipettes

10 $\mu$ L	120 $\mu$ L	300 $\mu$ L	1200 $\mu$ L
✓	✓	✓	✓



**MICROPLATE DOMINO**  
PN: 186009600

# Greiner, 384-well PP F-bottom black microplate

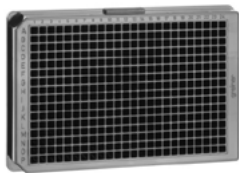

**Manufacturer:**  
Greiner Bio-One

**Part number:**  
781209

1-channel pipettes					
10 $\mu$ L	120 $\mu$ L	300 $\mu$ L	1000 $\mu$ L	5mL	10mL
✓	✓	✓	✓	✗	✗

  

8-channel pipettes			
10 $\mu$ L	120 $\mu$ L	300 $\mu$ L	1200 $\mu$ L
✓	✓	✓	✓



**MICROPLATE DOMINO**  
PN: 186009600

# Greiner, 384-well PS F-bottom clear microplate

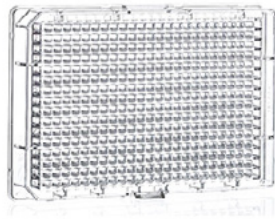

**Manufacturer:**  
Greiner Bio-One

**Part number:**  
781101

1-channel pipettes					
10 $\mu$ L	120 $\mu$ L	300 $\mu$ L	1000 $\mu$ L	5mL	10mL
✓	✓	✓	⚠	✗	✗

  

8-channel pipettes			
10 $\mu$ L	120 $\mu$ L	300 $\mu$ L	1200 $\mu$ L
✓	✓	✓	⚠



**MICROPLATE DOMINO**  
PN: 186009600

# Greiner, 384-well white Small Volume™ HiBase microplate

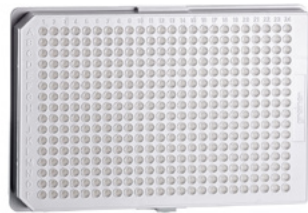

**Manufacturer:**  
Greiner Bio-One

**Part number:**  
784075

1-channel pipettes					
10µL	120µL	300µL	1000µL	5mL	10mL
✓	✓	✓	⚠	✗	✗

8-channel pipettes			
10µL	120µL	300µL	1200µL
✓	✓	✓	⚠



**MICROPLATE DOMINO**  
PN: 186009600

# Hard-Shell® 96-well low-profile skirted PCR plate, white/clear



**Manufacturer:**  
Bio-Rad Laboratories

**Part number:**  
HSP9601



1-channel pipettes					
10µL	120µL	300µL	1000µL	5mL	10mL
✓	✓	✓	✓	⚠	⚠

8-channel pipettes			
10µL	120µL	300µL	1200µL
✓	✓	✓	✓



MICROPLATE DOMINO  
PN: 186009600

# Hard-Shell® 384-well skirted PCR plate, black/white



**Manufacturer:**  
Bio-Rad Laboratories

**Part number:**  
HSP3865

1-channel pipettes					
10µL	120µL	300µL	1000µL	5mL	10mL
✓	✓	✓	⚠	✗	✗

8-channel pipettes			
10µL	120µL	300µL	1200µL
✓	✓	✓	⚠



MICROPLATE DOMINO  
PN: 186009600

# Hard-Shell® 384-well skirted PCR plate, clear/white



**Manufacturer:**  
Greiner Bio-One

**Part number:**  
HSP3805

1-channel pipettes					
10µL	120µL	300µL	1000µL	5mL	10mL
✓	✓	✓	⚠	✗	✗

8-channel pipettes			
10µL	120µL	300µL	1200µL
✓	✓	✓	⚠



MICROPLATE DOMINO  
PN: 186009600

# HardShell 96-well low-profile skirted PCR plate, blue/clear



**Manufacturer:**  
PerkinElmer, Inc.

**Part number:**  
6008870



## 1-channel pipettes

10 $\mu$ L	120 $\mu$ L	300 $\mu$ L	1000 $\mu$ L	5mL	10mL
✓	✓	✓	✓	⚠	⚠

## 8-channel pipettes

10 $\mu$ L	120 $\mu$ L	300 $\mu$ L	1200 $\mu$ L
✓	✓	✓	✓



MICROPLATE DOMINO  
PN: 186009600



# Headspace 10mL Screw-Thread Vials, in 15 positions rack



**Manufacturer:**  
Restek

**Part number:**  
23084

1-channel pipettes					
10 $\mu$ L	120 $\mu$ L	300 $\mu$ L	1000 $\mu$ L	5mL	10mL
✓	✓	✓	✓	✓	✓

8-channel pipettes			
10 $\mu$ L	120 $\mu$ L	300 $\mu$ L	1200 $\mu$ L
✗	✗	✗	✗



**MICROPLATE DOMINO**  
PN: 186009600

# Headspace 20mL Screw-Thread Vials, in 15 positions rack



**Manufacturer:**  
Restek

**Part number:**  
23082

1-channel pipettes					
10 $\mu$ L	120 $\mu$ L	300 $\mu$ L	1000 $\mu$ L	5mL	10mL
✓	✓	✓	✓	✓	<b>1 000</b>

  

8-channel pipettes			
10 $\mu$ L	120 $\mu$ L	300 $\mu$ L	1200 $\mu$ L
✗	✗	✗	✗



**MICROPLATE DOMINO**  
PN: 186009600

# High Binding 96-Stripwell™ Flat Bottom Microplate

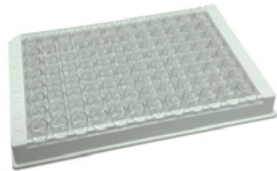

**Manufacturer:**  
Corning Inc.

**Part number:**  
7642

1-channel pipettes					
10µL	120µL	300µL	1000µL	5mL	10mL
✓	✓	✓	✓	✓	⚠

8-channel pipettes			
10µL	120µL	300µL	1200µL
✓	✓	✓	✓



**MICROPLATE DOMINO**  
PN: 186009600

# ibidi, 24-well ibiTreat black $\mu$ -Plate w/ polymer coverslip bottom



**Manufacturer:**  
ibidi

**Part number:**  
82426

1-channel pipettes					
10 $\mu$ L	120 $\mu$ L	300 $\mu$ L	1000 $\mu$ L	5mL	10mL
✓	✓	✓	✓	✓	✓

8-channel pipettes			
10 $\mu$ L	120 $\mu$ L	300 $\mu$ L	1200 $\mu$ L
✗	✗	✗	✗



**MICROPLATE DOMINO**  
PN: 186009600

# ibidi, 96-well ibiTreat black $\mu$ -Plate w/ polymer coverslip bottom



**Manufacturer:**  
ibidi

**Part number:**  
89626

## 1-channel pipettes

10 $\mu$ L	120 $\mu$ L	300 $\mu$ L	1000 $\mu$ L	5mL	10mL
✓	✓	✓	✓	✓	✓

## 8-channel pipettes

10 $\mu$ L	120 $\mu$ L	300 $\mu$ L	1200 $\mu$ L
✓	✓	✓	✓



**MICROPLATE DOMINO**  
PN: 186009600

# KingFisher™ 200uL Systems Consumable



**Manufacturer:**  
Thermo Scientific

**Part number:**  
97002084

1-channel pipettes					
10µL	120µL	300µL	1000µL	5mL	10mL
✓	✓	✓	✓	⚠	⚠

8-channel pipettes			
10µL	120µL	300µL	1200µL
✓	✓	✓	✓



**MICROPLATE DOMINO**  
PN: 186009600

# MicroAmp™ 40 µL optical 384-well skirted reaction plate w/ barcode



**Manufacturer:**  
Applied Biosystems

**Part number:**  
4309849

1-channel pipettes					
10µL	120µL	300µL	1000µL	5mL	10mL
✓	✓	✓	⚠	⚠	✗

  

8-channel pipettes			
10µL	120µL	300µL	1200µL
✓	✓	✓	⚠



**MICROPLATE DOMINO**  
PN: 186009600

# MICROLON<sup>®</sup> 200 96-well U-bottom microplate

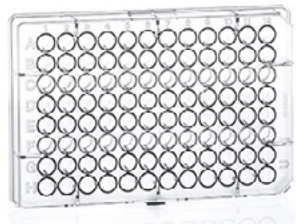

**Manufacturer:**  
Greiner Bio-One

**Part number:**  
650001

1-channel pipettes					
10 $\mu$ L	120 $\mu$ L	300 $\mu$ L	1000 $\mu$ L	5mL	10mL
✓	✓	✓	✓	⚠	⚠

8-channel pipettes			
10 $\mu$ L	120 $\mu$ L	300 $\mu$ L	1200 $\mu$ L
✓	✓	✓	✓



MICROPLATE DOMINO  
PN: 186009600



# MultiScreen® Solvinert™ 96-well filter plate, 0.45 µm pore size



**Manufacturer:**  
Merck

**Part number:**  
MSRLN0450

1-channel pipettes					
10µL	120µL	300µL	1000µL	5mL	10mL
✓	✓	✓	✓	⚠	⚠

8-channel pipettes			
10µL	120µL	300µL	1200µL
✓	✓	✓	✓



**MICROPLATE DOMINO**  
PN: 186009600

# Nunc™ 6-well cell culture-treated plate



**Manufacturer:**  
Thermo Scientific

**Part number:**  
140675

1-channel pipettes					
10µL	120µL	300µL	1000µL	5mL	10mL
✓	✓	✓	✓	✓	✓

8-channel pipettes			
10µL	120µL	300µL	1200µL
✗	✗	✗	✗



MICROPLATE DOMINO  
PN: 186009600

# Nunc™ 96-well Polypropylene Sample Plate



**Manufacturer:**  
Thermo Scientific

**Part number:**  
249944

1-channel pipettes					
10µL	120µL	300µL	1000µL	5mL	10mL
✓	✓	✓	✓	⚠	⚠

8-channel pipettes			
10µL	120µL	300µL	1200µL
✓	✓	✓	✓



**MICROPLATE DOMINO**  
PN: 186009600

# Nunc™ 96-Well Polypropylene Sample Plates



**Manufacturer:**  
Thermo Scientific

**Part number:**  
267334

1-channel pipettes					
10µL	120µL	300µL	1000µL	5mL	10mL
✓	✓	✓	✓	✓	✓

8-channel pipettes			
10µL	120µL	300µL	1200µL
✓	✓	✓	✓



**MICROPLATE DOMINO**  
PN: 186009600

# Nunc™ Edge™ 96-well cell culture-treated microplate



**Manufacturer:**  
Thermo Scientific

**Part number:**  
167425

1-channel pipettes					
10µL	120µL	300µL	1000µL	5mL	10mL
✓	✓	✓	✓	⚠	⚠

8-channel pipettes			
10µL	120µL	300µL	1200µL
✓	✓	✓	✓



**MICROPLATE DOMINO**  
PN: 186009600

# PerkinElmer, AlphaPlate-384 light gray microplate, untreated



**Manufacturer:**  
PerkinElmer, Inc.

**Part number:**  
6005350

1-channel pipettes					
10 $\mu$ L	120 $\mu$ L	300 $\mu$ L	1000 $\mu$ L	5mL	10mL
✓	✓	✓	✓	⚠	⚠

8-channel pipettes			
10 $\mu$ L	120 $\mu$ L	300 $\mu$ L	1200 $\mu$ L
✓	✓	✓	✓



**MICROPLATE DOMINO**  
PN: 186009600

# PerkinElmer, DBS microplate



**Manufacturer:**  
PerkinElmer, Inc.

**Part number:**  
3033-0010

1-channel pipettes					
10 $\mu$ L	120 $\mu$ L	300 $\mu$ L	1000 $\mu$ L	5mL	10mL
✓	✓	✓	✓	⚠	⚠

8-channel pipettes			
10 $\mu$ L	120 $\mu$ L	300 $\mu$ L	1200 $\mu$ L
✓	✓	✓	✓



**MICROPLATE DOMINO**  
PN: 186009600

# Pierce™ 96-Well Polystyrene Plates with Corner Notch



**Manufacturer:**  
Thermo Scientific

**Part number:**  
15041

1-channel pipettes					
10 $\mu$ L	120 $\mu$ L	300 $\mu$ L	1000 $\mu$ L	5mL	10mL
✓	✓	✓	✓	✓	⚠

8-channel pipettes			
10 $\mu$ L	120 $\mu$ L	300 $\mu$ L	1200 $\mu$ L
✓	✓	✓	✓



**MICROPLATE DOMINO**  
PN: 186009600



# ProteinSimple, Simple Plex™ 72x1 cartridge



**Manufacturer:**  
ProteinSimple

**Part number:**  
N/A

1-channel pipettes					
10µL	120µL	300µL	1000µL	5mL	10mL
✓	✓	✓	✓	✗	✗

8-channel pipettes			
10µL	120µL	300µL	1200µL
✓	✓	✓	✓



MICROPLATE DOMINO  
PN: 186009600

# ProxiPlate™-384 Plus white shallow-well microplate



**Manufacturer:**  
PerkinElmer, Inc.

**Part number:**  
6008280

1-channel pipettes					
10µL	120µL	300µL	1000µL	5mL	10mL
✓	✓	🧪	🧪	🧪	🧪

  

8-channel pipettes			
10µL	120µL	300µL	1200µL
✓	✓	🧪	🧪



**MICROPLATE DOMINO**  
PN: 186009600

# SAFE<sup>®</sup> 2D MX 500 external thread tube in 96x rack

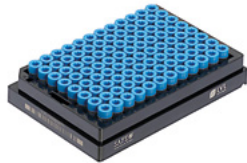

**Manufacturer:**  
LVL technologies

**Part number:**  
2DNC-X05-BL-NS-  
SLP-L

1-channel pipettes					
10 $\mu$ L	120 $\mu$ L	300 $\mu$ L	1000 $\mu$ L	5mL	10mL
✓	✓	✓	<b>150</b>		✗

8-channel pipettes			
10 $\mu$ L	120 $\mu$ L	300 $\mu$ L	1200 $\mu$ L
✓	✓	✓	✓



**MICROPLATE DOMINO**  
PN: 186009600

# Thermo Scientific™ 0.3 mL 96-well U-bottom MaxiSorp Immuno plate



**Manufacturer:**  
Thermo Scientific

**Part number:**  
449824

1-channel pipettes					
10µL	120µL	300µL	1000µL	5mL	10mL
✓	✓	✓	✓	✓	✓

8-channel pipettes			
10µL	120µL	300µL	1200µL
✓	✓	✓	✓



**MICROPLATE DOMINO**  
PN: 186009600

# Thermo Scientific™ 400 $\mu$ L Immuno Standard black 16-well strips in 96x plate



**Manufacturer:**  
Thermo Scientific

**Part number:**  
475515

1-channel pipettes					
10 $\mu$ L	120 $\mu$ L	300 $\mu$ L	1000 $\mu$ L	5mL	10mL
✓	✓	✓	✓	⚠	⚠

8-channel pipettes			
10 $\mu$ L	120 $\mu$ L	300 $\mu$ L	1200 $\mu$ L
✓	✓	✓	✓



**MICROPLATE DOMINO**  
PN: 186009600

# Thermo Scientific™ KingFisher™ 96-well microplate



**Manufacturer:**  
Thermo Scientific

**Part number:**  
97002540

1-channel pipettes					
10µL	120µL	300µL	1000µL	5mL	10mL
✓	✓	✓	✓	✓	⚠

8-channel pipettes			
10µL	120µL	300µL	1200µL
✓	✓	✓	✓



**MICROPLATE DOMINO**  
PN: 186009600

# Thermo Scientific™ Nunc MicroWell 96-well plate



**Manufacturer:**  
Thermo Scientific

**Part number:**  
269620

1-channel pipettes					
10 $\mu$ L	120 $\mu$ L	300 $\mu$ L	1000 $\mu$ L	5mL	10mL
✓	✓	✓	✓	⚠	⚠

  

8-channel pipettes			
10 $\mu$ L	120 $\mu$ L	300 $\mu$ L	1200 $\mu$ L
✓	✓	✓	✓



**MICROPLATE DOMINO**  
PN: 186009600

# TPP 12-well tissue culture test plate

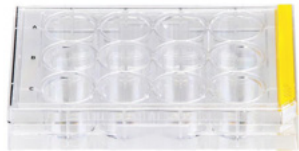

**Manufacturer:**  
TPP AG

**Part number:**  
92412



1-channel pipettes					
10 $\mu$ L	120 $\mu$ L	300 $\mu$ L	1000 $\mu$ L	5mL	10mL
✓	✓	✓	✓	✓	✓

8-channel pipettes			
10 $\mu$ L	120 $\mu$ L	300 $\mu$ L	1200 $\mu$ L
✗	✗	✗	✗



MICROPLATE DOMINO  
PN: 186009600



# Unchained Labs, Big Lunatic plate



**Manufacturer:**  
Unchained Labs

**Part number:**  
N/A

1-channel pipettes					
10 $\mu$ L	120 $\mu$ L	300 $\mu$ L	1000 $\mu$ L	5mL	10mL
✓	✗	✗	✗	✗	✗

  

8-channel pipettes			
10 $\mu$ L	120 $\mu$ L	300 $\mu$ L	1200 $\mu$ L
✓	✗	✗	✗



**MICROPLATE DOMINO**  
PN: 186009600

# UV-Star® $\mu$ Clear® 96-well F-bottom half-area microplate

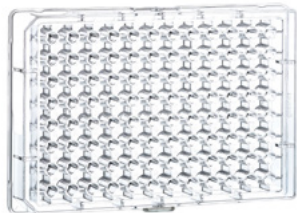

**Manufacturer:**  
Greiner Bio-One

**Part number:**  
675801

1-channel pipettes					
10 $\mu$ L	120 $\mu$ L	300 $\mu$ L	1000 $\mu$ L	5mL	10mL
✓	✓	✓	✓	⚠	⚠

8-channel pipettes			
10 $\mu$ L	120 $\mu$ L	300 $\mu$ L	1200 $\mu$ L
✓	✓	✓	✓



**MICROPLATE DOMINO**  
PN: 186009600

# UV-Star® $\mu$ Clear® 96-well F-bottom microplate



**Manufacturer:**  
Greiner Bio-One

**Part number:**  
655801

1-channel pipettes					
10 $\mu$ L	120 $\mu$ L	300 $\mu$ L	1000 $\mu$ L	5mL	10mL
✓	✓	✓	✓	✗	✗

8-channel pipettes			
10 $\mu$ L	120 $\mu$ L	300 $\mu$ L	1200 $\mu$ L
✓	✓	✓	✓



**MICROPLATE DOMINO**  
PN: 186009600

# Valita® Titer assay plate



**Manufacturer:**  
ValitaCell

**Part number:**  
VAL003

1-channel pipettes					
10µL	120µL	300µL	1000µL	5mL	10mL
✓	✓	✓	✓	✓	✓

8-channel pipettes			
10µL	120µL	300µL	1200µL
✓	✓	✓	✓



**MICROPLATE DOMINO**  
PN: 186009600

# Valita® Titer plate



**Manufacturer:**  
ValitaCell

**Part number:**  
VAL003

1-channel pipettes					
10µL	120µL	300µL	1000µL	5mL	10mL
✓	✓	✓	✓	✓	✓

8-channel pipettes			
10µL	120µL	300µL	1200µL
✓	✓	✓	✓



**MICROPLATE DOMINO**  
PN: 186009600

# Waters 250 $\mu$ L 384-square well collection plate



SEE THIS CONSUMABLE  
ON OUR E-SHOP

**Manufacturer:**  
Waters Corporation

**Part number:**  
186002632

1-channel pipettes					
10 $\mu$ L	120 $\mu$ L	300 $\mu$ L	1000 $\mu$ L	5mL	10mL
✓	✓	75	150	🧪	🧪

8-channel pipettes			
10 $\mu$ L	120 $\mu$ L	300 $\mu$ L	1200 $\mu$ L
✗	✗	✗	✗



MICROPLATE DOMINO  
PN: 186009600

# Waters 350 $\mu$ L 96-round well collection plate



SEE THIS CONSUMABLE  
ON OUR E-SHOP

**Manufacturer:**  
Waters Corporation

**Part number:**  
186002643



## 1-channel pipettes

10 $\mu$ L	120 $\mu$ L	300 $\mu$ L	1000 $\mu$ L	5mL	10mL
✓	✓	✓	✓	✓	✓

## 8-channel pipettes

10 $\mu$ L	120 $\mu$ L	300 $\mu$ L	1200 $\mu$ L
✓	✓	✓	✓



MICROPLATE DOMINO  
PN: 186009600

# WebSeal 0.5 mL 96-well V-bottom plate



**Manufacturer:**  
Thermo Scientific

**Part number:**  
60180-P100



1-channel pipettes					
10 $\mu$ L	120 $\mu$ L	300 $\mu$ L	1000 $\mu$ L	5mL	10mL
✓	✓	✓	✓	⚠	⚠

8-channel pipettes			
10 $\mu$ L	120 $\mu$ L	300 $\mu$ L	1200 $\mu$ L
✓	✓	✓	✓



MICROPLATE DOMINO  
PN: 186009600



Ordering product number

**186009597**

OneLab reference: [218.2301]

## DEEPWELL MICROPLATE DOMINO



The Deepwell Microplate Domino is designed to hold a growing array of Deepwell plates and reagent reservoirs capable of holding large volumes.

**SEE THIS DOMINO  
ON OUR E-SHOP**

# 2 mL aluminum 48-well reaction block

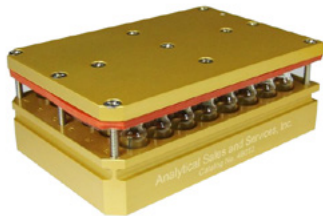

**Manufacturer:**  
Analytical Sales  
& Services, Inc.

**Part number:**  
48012

1-channel pipettes					
10 $\mu$ L	120 $\mu$ L	300 $\mu$ L	1000 $\mu$ L	5mL	10mL
✓	✓	✓	1 100	1 200	🧪

8-channel pipettes			
10 $\mu$ L	120 $\mu$ L	300 $\mu$ L	1200 $\mu$ L
✗	✗	✗	✗



DEEPWELL MICROPLATE  
DOMINO  
PN: 186009597

# 4 mL aluminum 24-well reaction block



**Manufacturer:**  
Analytical Sales  
& Services, Inc.

**Part number:**  
24015

1-channel pipettes					
10 $\mu$ L	120 $\mu$ L	300 $\mu$ L	1000 $\mu$ L	5mL	10mL
✓	✓	✓	✓	2 500	🧪

8-channel pipettes			
10 $\mu$ L	120 $\mu$ L	300 $\mu$ L	1200 $\mu$ L
✗	✗	✗	✗



DEEPWELL MICROPLATE  
DOMINO  
PN: 186009597

# 8 mL aluminum 24-well reaction block



**Manufacturer:**  
Analytical Sales  
& Services, Inc.

**Part number:**  
24017

1-channel pipettes					
10 $\mu$ L	120 $\mu$ L	300 $\mu$ L	1000 $\mu$ L	5mL	10mL
✓	✓	✓	✓	3 000	6 000

8-channel pipettes			
10 $\mu$ L	120 $\mu$ L	300 $\mu$ L	1200 $\mu$ L
✗	✗	✗	✗



DEEPWELL MICROPLATE  
DOMINO  
PN: 186009597

# 96-well photoredox block assembly



**Manufacturer:**  
Analytical Sales  
& Services, Inc.

**Part number:**  
96973

1-channel pipettes					
10 $\mu$ L	120 $\mu$ L	300 $\mu$ L	1000 $\mu$ L	5mL	10mL
200	✓	✓	400	400	600

  

8-channel pipettes			
10 $\mu$ L	120 $\mu$ L	300 $\mu$ L	1200 $\mu$ L
200	✓	✓	✓



DEEPWELL MICROPLATE  
DOMINO  
PN: 186009597

# Abgene™ 0.8 mL 96-deep well storage plate

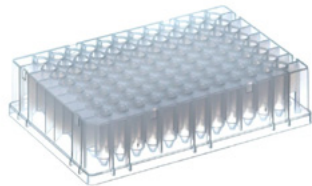

**Manufacturer:**  
Thermo Scientific

**Part number:**  
AB0859



1-channel pipettes					
10µL	120µL	300µL	1000µL	5mL	10mL
✓	✓	✓	50	200	400

8-channel pipettes			
10µL	120µL	300µL	1200µL
200	✓	✓	✓



DEEPPWELL MICROPLATE  
DOMINO  
PN: 186009597

# Abgene™ 2.2mL 96-well Deepwell Sample Plate



**Manufacturer:**  
Thermo Scientific

**Part number:**  
AB-0661

1-channel pipettes					
10µL	120µL	300µL	1000µL	5mL	10mL
✓	✓	✓	✓	✓	✓

8-channel pipettes			
10µL	120µL	300µL	1200µL
600	✓	✓	✓



DEEPWELL MICROPLATE  
DOMINO  
PN: 186009597

# Abgene™ 96 Well 1.2mL Deepwell Plate



**Manufacturer:**  
Thermo Scientific

**Part number:**  
AB1127

1-channel pipettes					
10µL	120µL	300µL	1000µL	5mL	10mL
✓	✓	✓	800	✓	✓

8-channel pipettes			
10µL	120µL	300µL	1200µL
300	✓	✓	200



DEEPWELL MICROPLATE  
DOMINO  
PN: 186009597



# AcroPrep™ 24-well collection plate



**Manufacturer:**  
Pall Corporation

**Part number:**  
NA



## 1-channel pipettes

10µL	120µL	300µL	1000µL	5mL	10mL
✓	✓	✓	✓	✓	✓

## 8-channel pipettes

10µL	120µL	300µL	1200µL
✗	✗	✗	✗



DEEPWELL MICROPLATE  
DOMINO  
PN: 186009597

# Agilent 6-column reagent reservoir



**Manufacturer:**  
Agilent Technologies

**Part number:**  
201284-100

1-channel pipettes					
10 $\mu$ L	120 $\mu$ L	300 $\mu$ L	1000 $\mu$ L	5mL	10mL
✓	✓	✓	✓	✓	✓

8-channel pipettes			
10 $\mu$ L	120 $\mu$ L	300 $\mu$ L	1200 $\mu$ L
6 000	✓	✓	✓



DEEPWELL MICROPLATE  
DOMINO  
PN: 186009597

# Agilent 12-column reagent reservoir



**Manufacturer:**  
Agilent Technologies

**Part number:**  
201256-100

1-channel pipettes					
10 $\mu$ L	120 $\mu$ L	300 $\mu$ L	1000 $\mu$ L	5mL	10mL
✓	✓	✓	✓	✓	<b>16 000</b>

8-channel pipettes			
10 $\mu$ L	120 $\mu$ L	300 $\mu$ L	1200 $\mu$ L
<b>10 000</b>	✓	✓	✓



**DEERWELL MICROPLATE**  
**DOMINO**  
PN: 186009597

# Agilent 96-well plate, 2.2 mL



**Manufacturer:**  
Agilent Technologies

**Part number:**  
5043-9300



1-channel pipettes					
10 $\mu$ L	120 $\mu$ L	300 $\mu$ L	1000 $\mu$ L	5mL	10mL
✓	✓	✓	✓	<b>300</b>	<b>750</b>

8-channel pipettes			
10 $\mu$ L	120 $\mu$ L	300 $\mu$ L	1200 $\mu$ L
<b>300</b>	✓	✓	✓



**DEEPWELL MICROPLATE**  
**DOMINO**  
PN: 186009597

# ArcticWhite, 21 mL 12-column reservoir



**Manufacturer:**  
ArcticWhite LLC

**Part number:**  
AWLS-S30019

1-channel pipettes					
10 $\mu$ L	120 $\mu$ L	300 $\mu$ L	1000 $\mu$ L	5mL	10mL
✓	✓	✓	✓	5 000	10 000

8-channel pipettes			
10 $\mu$ L	120 $\mu$ L	300 $\mu$ L	1200 $\mu$ L
✓	✓	✓	✓



DEEPWELL MICROPLATE  
DOMINO  
PN: 186009597

# ArcticWhite, 73 mL 4-column reservoir



**Manufacturer:**  
ArcticWhite LLC

**Part number:**  
AWLS-S30051

## 1-channel pipettes

10 $\mu$ L	120 $\mu$ L	300 $\mu$ L	1000 $\mu$ L	5mL	10mL
✓	✓	✓	✓	✓	✓

## 8-channel pipettes

10 $\mu$ L	120 $\mu$ L	300 $\mu$ L	1200 $\mu$ L
✓	✓	✓	✓



DEEPWELL MICROPLATE  
DOMINO  
PN: 186009597

# Axygen® 1.1 mL 96-round deep well U-bottom plate



**Manufacturer:**  
Corning Inc.

**Part number:**  
P-DW-11-C



## 1-channel pipettes

10µL	120µL	300µL	1000µL	5mL	10mL
✓	✓	✓	✓	✓	✓

## 8-channel pipettes

10µL	120µL	300µL	1200µL
<b>300</b>	✓	✓	✓



DEEPWELL MICROPLATE  
DOMINO  
PN: 186009597

# Axygen® 10 mL 24-square deep well V-bottom plate



**Manufacturer:**  
Corning Inc.

**Part number:**  
P-DW-10ML-24-C-S



1-channel pipettes					
10µL	120µL	300µL	1000µL	5mL	10mL
✓	✓	✓	✓	✓	✓

8-channel pipettes			
10µL	120µL	300µL	1200µL
✗	✗	✗	✗



DEEPWELL MICROPLATE  
DOMINO  
PN: 186009597



# Axygen<sup>®</sup> 8-well reservoir, 8-channel trough



**Manufacturer:**  
Corning Inc.

**Part number:**  
RES-MW8-HP

1-channel pipettes					
10 $\mu$ L	120 $\mu$ L	300 $\mu$ L	1000 $\mu$ L	5mL	10mL
✓	✓	✓	✓	15 000	15 000

8-channel pipettes			
10 $\mu$ L	120 $\mu$ L	300 $\mu$ L	1200 $\mu$ L
15 000	✓	✓	✓



DEERWELL MICROPLATE  
DOMINO  
PN: 186009597

# Axygen® 12-well reservoir, 12-channel trough



**Manufacturer:**  
Corning Inc.

**Part number:**  
RES-MW12-HP

1-channel pipettes					
10µL	120µL	300µL	1000µL	5mL	10mL
✓	✓	✓	✓	7 500	7 500

8-channel pipettes			
10µL	120µL	300µL	1200µL
7 500	✓	✓	✓



DEEPWELL MICROPLATE  
DOMINO  
PN: 186009597

# BRAND® 1.1 mL 96-deep well U-bottom plate



**Manufacturer:**  
BRAND

**Part number:**  
701350

1-channel pipettes					
10µL	120µL	300µL	1000µL	5mL	10mL
✓	✓	✓	<b>700</b>	<b>500</b>	

8-channel pipettes			
10µL	120µL	300µL	1200µL
<b>15 000</b>	✓	✓	✓



DEEPWELL MICROPLATE  
DOMINO  
PN: 186009597

# Corning® 1.2 mL 8 cluster tube-strip in 96x rack



**Manufacturer:**  
Corning Inc.

**Part number:**  
4412

1-channel pipettes					
10µL	120µL	300µL	1000µL	5mL	10mL
<b>400</b>	<b>200</b>	<b>200</b>	<b>700</b>		

8-channel pipettes			
10µL	120µL	300µL	1200µL
<b>400</b>	<b>200</b>	<b>200</b>	<b>300</b>



DEEPWELL MICROPLATE  
DOMINO  
PN: 186009597

# Corning® 2 mL 96-square deep well V-bottom plate



**Manufacturer:**  
Corning Inc.

**Part number:**  
3960



1-channel pipettes					
10µL	120µL	300µL	1000µL	5mL	10mL
✓	✓	✓	✓	<b>700</b>	

8-channel pipettes			
10µL	120µL	300µL	1200µL
<b>800</b>	✓	✓	✓



**DEEPPWELL MICROPLATE**  
**DOMINO**  
PN: 186009597

# Cytiva, UNIPLATE 5 mL 48-well flat bottom plate



**Manufacturer:**

Cytiva

**Part number:**

7701-5500

1-channel pipettes					
10 $\mu$ L	120 $\mu$ L	300 $\mu$ L	1000 $\mu$ L	5mL	10mL
✓	✓	✓	✓	<b>3 000</b>	<b>3 000</b>

8-channel pipettes			
10 $\mu$ L	120 $\mu$ L	300 $\mu$ L	1200 $\mu$ L
<b>2 500</b>	✓	✓	✓



DEEPWELL MICROPLATE  
DOMINO  
PN: 186009597

# Cytiva, UNIPLATE 10 mL 24-well U-shaped plate



**Manufacturer:**

Cytiva

**Part number:**

7701-5102

## 1-channel pipettes

10 $\mu$ L	120 $\mu$ L	300 $\mu$ L	1000 $\mu$ L	5mL	10mL
✓	✓	✓	✓	✓	✓

## 8-channel pipettes

10 $\mu$ L	120 $\mu$ L	300 $\mu$ L	1200 $\mu$ L
✗	✗	✗	✗



DEEPWELL MICROPLATE  
DOMINO  
PN: 186009597

# Eppendorf 0.5 mL 96-deep well protein LoBind® plate, yellow frame



**Manufacturer:**  
Eppendorf

**Part number:**  
0030504119



1-channel pipettes					
10µL	120µL	300µL	1000µL	5mL	10mL
✓	✓	✓	✓	✓	<b>300</b>

8-channel pipettes			
10µL	120µL	300µL	1200µL
<b>300</b>	✓	✓	✓



**DEEPWELL MICROPLATE**  
**DOMINO**  
PN: 186009597



# Eppendorf 1 mL 96-deep well protein LoBind<sup>®</sup> plate, yellow frame



**Manufacturer:**  
Eppendorf

**Part number:**  
0030504216



Compatible with  
Microplate  
Gripper

## 1-channel pipettes

10 $\mu$ L	120 $\mu$ L	300 $\mu$ L	1000 $\mu$ L	5mL	10mL
✓	✓	✓	<b>600</b>	<b>650</b>	

## 8-channel pipettes

10 $\mu$ L	120 $\mu$ L	300 $\mu$ L	1200 $\mu$ L
<b>500</b>	✓	✓	✓



DEEPPWELL MICROPLATE  
DOMINO  
PN: 186009597

# Eppendorf 2 mL 96-deep well protein LoBind® plate, white frame



**Manufacturer:**  
Eppendorf

**Part number:**  
0030504305



1-channel pipettes					
10µL	120µL	300µL	1000µL	5mL	10mL
✓	✓	✓	✓	<b>700</b>	<b>1 300</b>

8-channel pipettes			
10µL	120µL	300µL	1200µL
<b>900</b>	✓	✓	✓



**DEEPWELL MICROPLATE**  
**DOMINO**  
PN: 186009597

# Eppendorf 2 mL 96-square deep well plate, yellow frame



**Manufacturer:**  
Eppendorf

**Part number:**  
0030501314



1-channel pipettes					
10 $\mu$ L	120 $\mu$ L	300 $\mu$ L	1000 $\mu$ L	5mL	10mL
✓	✓	✓	✓	<b>700</b>	<b>1 300</b>

8-channel pipettes			
10 $\mu$ L	120 $\mu$ L	300 $\mu$ L	1200 $\mu$ L
<b>500</b>	✓	✓	✓



**DEEPWELL MICROPLATE**  
**DOMINO**  
PN: 186009597

# Eppendorf™ Deepwell™ Plates 96



**Manufacturer:**  
Eppendorf

**Part number:**  
951033308

1-channel pipettes					
10µL	120µL	300µL	1000µL	5mL	10mL
✓	✓	✓	500	500	700

8-channel pipettes			
10µL	120µL	300µL	1200µL
300	✓	✓	✓



**DEEPWELL MICROPLATE**  
**DOMINO**  
PN: 186009597

# Fisherbrand™ 1 mL 96-well U-bottom DeepWell™ microplate



**Manufacturer:**  
Fisher Scientific

**Part number:**  
11381555

1-channel pipettes					
10µL	120µL	300µL	1000µL	5mL	10mL
✓	✓	✓	✓	✓	<b>300</b>

8-channel pipettes			
10µL	120µL	300µL	1200µL
✓	✓	✓	✓



**DEEPWELL MICROPLATE**  
**DOMINO**  
PN: 186009597

# ILS, 12-channel reagent reservoir



**Manufacturer:**  
Irish Life Sciences

**Part number:**  
Res12-351

1-channel pipettes					
10 $\mu$ L	120 $\mu$ L	300 $\mu$ L	1000 $\mu$ L	5mL	10mL
✓	✓	✓	✓	✓	✓

8-channel pipettes			
10 $\mu$ L	120 $\mu$ L	300 $\mu$ L	1200 $\mu$ L
6 500	✓	✓	✓



DEEPWELL MICROPLATE  
DOMINO  
PN: 186009597

# KingFisher 96-deep well V-bottom plate



**Manufacturer:**  
Thermo Scientific

**Part number:**  
95040450



1-channel pipettes					
10 $\mu$ L	120 $\mu$ L	300 $\mu$ L	1000 $\mu$ L	5mL	10mL
✓	✓	✓	✓	<b>700</b>	<b>1 300</b>

8-channel pipettes			
10 $\mu$ L	120 $\mu$ L	300 $\mu$ L	1200 $\mu$ L
<b>500</b>	✓	✓	✓



**DEEPWELL MICROPLATE**  
**DOMINO**  
PN: 186009597

# MagNA Pure 96 processing cartridge



**Manufacturer:**  
Roche

**Part number:**  
06241603001

1-channel pipettes					
10 $\mu$ L	120 $\mu$ L	300 $\mu$ L	1000 $\mu$ L	5mL	10mL
✓	✓	✓	500	1 300	1 700

8-channel pipettes			
10 $\mu$ L	120 $\mu$ L	300 $\mu$ L	1200 $\mu$ L
1 500	1 000	500	✓



DEEPWELL MICROPLATE  
DOMINO  
PN: 186009597



# Matrix 1.0 mL Deepwell Storage Blocks



**Manufacturer:**  
Thermo Scientific

**Part number:**  
4211-11

1-channel pipettes					
10 $\mu$ L	120 $\mu$ L	300 $\mu$ L	1000 $\mu$ L	5mL	10mL
✓	✓	✓	500	400	600

8-channel pipettes			
10 $\mu$ L	120 $\mu$ L	300 $\mu$ L	1200 $\mu$ L
200	✓	✓	✓



DEEPWELL MICROPLATE  
DOMINO  
PN: 186009597

# Nunc™ 1.3 mL 96-DeepWell™ plate



**Manufacturer:**  
Thermo Scientific

**Part number:**  
260251



## 1-channel pipettes

10µL	120µL	300µL	1000µL	5mL	10mL
✓	✓	✓	✓	✓	✓

## 8-channel pipettes

10µL	120µL	300µL	1200µL
✓	✓	✓	✓



DEEPWELL MICROPLATE  
DOMINO  
PN: 186009597

# Nunc™ 2 mL 96-DeepWell™ plate



**Manufacturer:**  
Thermo Scientific

**Part number:**  
278743



1-channel pipettes					
10µL	120µL	300µL	1000µL	5mL	10mL
✓	✓	✓	✓	<b>500</b>	<b>1 200</b>

8-channel pipettes			
10µL	120µL	300µL	1200µL
<b>500</b>	✓	✓	✓



DEEPWELL MICROPLATE  
DOMINO  
PN: 186009597

# Porvair, 2 mL 96-deep well U-bottom plate



**Manufacturer:**  
Porvair Sciences

**Part number:**  
219020



1-channel pipettes					
10 $\mu$ L	120 $\mu$ L	300 $\mu$ L	1000 $\mu$ L	5mL	10mL
✓	✓	✓	✓	1 000	1 500

8-channel pipettes			
10 $\mu$ L	120 $\mu$ L	300 $\mu$ L	1200 $\mu$ L
✓	✓	✓	✓



DEEPWELL MICROPLATE  
DOMINO  
PN: 186009597

# SAFE<sup>®</sup> 2D/1D XLX 2000 external thread tube in 48x rack



**Manufacturer:**

LVL technologies

**Part number:**

2DSC-X20-BL-NS-SLP-L

1-channel pipettes					
10µL	120µL	300µL	1000µL	5mL	10mL
✓	✓	✓	✓	<b>500</b>	<b>1 000</b>

8-channel pipettes			
10µL	120µL	300µL	1200µL
✗	✗	✗	✗



DEEPWELL MICROPLATE  
DOMINO  
PN: 186009597

# Riplate® Medio 1mL Deepwell Plate



**Manufacturer:**  
Carl Roth

**Part number:**  
TC22.1

1-channel pipettes					
10µL	120µL	300µL	1000µL	5mL	10mL
✓	✓	✓	✓	✓	✓

8-channel pipettes			
10µL	120µL	300µL	1200µL
450	✓	✓	✓



DEEPWELL MICROPLATE  
DOMINO  
PN: 186009597

# Riplate® 2mL Deepwell Plate



**Manufacturer:**  
Carl Roth

**Part number:**  
EN07.1

1-channel pipettes					
10µL	120µL	300µL	1000µL	5mL	10mL
✓	✓	✓	✓	<b>800</b>	<b>1 200</b>

8-channel pipettes			
10µL	120µL	300µL	1200µL
<b>600</b>	✓	✓	✓



**DEEPWELL MICROPLATE**  
**DOMINO**  
PN: 186009597

# SAFE® LX 1000 2D external thread tube in SBS 96x rack



**Manufacturer:**  
LVL technologies

**Part number:**  
4C-X10-BL-AW-B-L

1-channel pipettes					
10µL	120µL	300µL	1000µL	5mL	10mL
✓	150	150	600	700	800

8-channel pipettes			
10µL	120µL	300µL	1200µL
400	150	150	150



DEEPWELL MICROPLATE  
DOMINO  
PN: 186009597



# Sartorius, 24-deep well V-bottom plate



**Manufacturer:**  
Sartorius

**Part number:**  
A-0038



1-channel pipettes					
10 $\mu$ L	120 $\mu$ L	300 $\mu$ L	1000 $\mu$ L	5mL	10mL
✓	✓	✓	✓	✓	✓

  

8-channel pipettes			
10 $\mu$ L	120 $\mu$ L	300 $\mu$ L	1200 $\mu$ L
✗	✗	✗	✗



DEEPWELL MICROPLATE  
DOMINO  
PN: 186009597

# Thermo Scientific™ 100 mL reagent reservoir

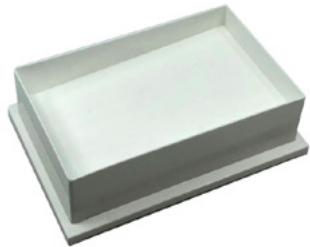

**Manufacturer:**  
Thermo Scientific

**Part number:**  
9510047

1-channel pipettes					
10 $\mu$ L	120 $\mu$ L	300 $\mu$ L	1000 $\mu$ L	5mL	10mL
✓	✓	✓	✓	✓	✓

8-channel pipettes			
10 $\mu$ L	120 $\mu$ L	300 $\mu$ L	1200 $\mu$ L
✓	✓	✓	✓



DEEPWELL MICROPLATE  
DOMINO  
PN: 186009597

# Valita® Titer plate



**Manufacturer:**  
ValitaCell

**Part number:**  
VAL003

1-channel pipettes					
10µL	120µL	300µL	1000µL	5mL	10mL
✓	✓	✓	✓	✓	✓

8-channel pipettes			
10µL	120µL	300µL	1200µL
✓	✓	✓	✓



DEEPWELL MICROPLATE  
DOMINO  
PN: 186009597

# Waters 2 mL 96-square well collection plate, cut corner A1/H1



SEE THIS CONSUMABLE  
ON OUR E-SHOP

**Manufacturer:**  
Waters

**Part number:**  
WAT058958

1-channel pipettes					
10 $\mu$ L	120 $\mu$ L	300 $\mu$ L	1000 $\mu$ L	5mL	10mL
✓	✓	✓	✓	<b>300</b>	<b>850</b>

8-channel pipettes			
10 $\mu$ L	120 $\mu$ L	300 $\mu$ L	1200 $\mu$ L
✓	✓	✓	✓



DEEPWELL MICROPLATE  
DOMINO  
PN: 186009597

# Waters 2 mL 96-square well collection plate, cut corner H1



SEE THIS CONSUMABLE  
ON OUR E-SHOP

**Manufacturer:**  
Waters

**Part number:**  
186002482



1-channel pipettes					
10 $\mu$ L	120 $\mu$ L	300 $\mu$ L	1000 $\mu$ L	5mL	10mL
✓	✓	✓	✓	<b>300</b>	<b>850</b>

8-channel pipettes			
10 $\mu$ L	120 $\mu$ L	300 $\mu$ L	1200 $\mu$ L
✓	✓	✓	✓



DEEPWELL MICROPLATE  
DOMINO  
PN: 186009597

# Waters 10 mL 24-square well collection plate



SEE THIS CONSUMABLE  
ON OUR E-SHOP

**Manufacturer:**  
Waters Corporation

**Part number:**  
186005586



1-channel pipettes					
10 $\mu$ L	120 $\mu$ L	300 $\mu$ L	1000 $\mu$ L	5mL	10mL
✓	✓	✓	✓	✓	✓

  

8-channel pipettes			
10 $\mu$ L	120 $\mu$ L	300 $\mu$ L	1200 $\mu$ L
✗	✗	✗	✗



DEEPWELL MICROPLATE  
DOMINO  
PN: 186009597

# Waters 350 $\mu$ L 96-square well collection plate

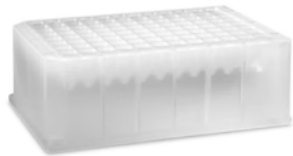

SEE THIS CONSUMABLE  
ON OUR E-SHOP

**Manufacturer:**  
Waters Corporation

**Part number:**  
WAT058943

1-channel pipettes					
10 $\mu$ L	120 $\mu$ L	300 $\mu$ L	1000 $\mu$ L	5mL	10mL
✓	✓	✓	✓	⚠	⚠

8-channel pipettes			
10 $\mu$ L	120 $\mu$ L	300 $\mu$ L	1200 $\mu$ L
✓	✓	✓	✓



DEEPWELL MICROPLATE  
DOMINO  
PN: 186009597

# Waters 700 $\mu$ L 96-round well collection plate



SEE THIS CONSUMABLE  
ON OUR E-SHOP

**Manufacturer:**  
Waters

**Part number:**  
186005837



1-channel pipettes					
10 $\mu$ L	120 $\mu$ L	300 $\mu$ L	1000 $\mu$ L	5mL	10mL
✓	✓	✓	100	100	

8-channel pipettes			
10 $\mu$ L	120 $\mu$ L	300 $\mu$ L	1200 $\mu$ L
200	✓	✓	✓



DEEPWELL MICROPLATE  
DOMINO  
PN: 186009597



# Waters 800 $\mu$ L 96-round well collection plate



SEE THIS CONSUMABLE  
ON OUR E-SHOP

**Manufacturer:**  
Waters Corporation

**Part number:**  
186002481



1-channel pipettes					
10 $\mu$ L	120 $\mu$ L	300 $\mu$ L	1000 $\mu$ L	5mL	10mL
✓	✓	✓	50	200	400

8-channel pipettes			
10 $\mu$ L	120 $\mu$ L	300 $\mu$ L	1200 $\mu$ L
200	✓	✓	✓



DEEPWELL MICROPLATE  
DOMINO  
PN: 186009597

# Waters QuanRecovery™ 700 µL 96-well plate



SEE THIS CONSUMABLE  
ON OUR E-SHOP

**Manufacturer:**  
Waters

**Part number:**  
186009185



1-channel pipettes					
10µL	120µL	300µL	1000µL	5mL	10mL
✓	✓	✓	50	200	400

8-channel pipettes			
10µL	120µL	300µL	1200µL
200	✓	✓	✓



DEEPWELL MICROPLATE  
DOMINO  
PN: 186009597

# WebSeal 2 mL 96-deep well U-bottom plate



**Manufacturer:**  
Thermo Scientific

**Part number:**  
60180-P104



1-channel pipettes					
10 $\mu$ L	120 $\mu$ L	300 $\mu$ L	1000 $\mu$ L	5mL	10mL
✓	✓	✓	✓	1 000	1 000

8-channel pipettes			
10 $\mu$ L	120 $\mu$ L	300 $\mu$ L	1200 $\mu$ L
✓	✓	✓	✓



DEEPWELL MICROPLATE  
DOMINO  
PN: 186009597

# Whatman® 96 wells, 2 mL uniplate



**Manufacturer:**  
Whatman

**Part number:**  
7701-5200

1-channel pipettes					
10µL	120µL	300µL	1000µL	5mL	10mL
✓	✓	✓	✓	<b>500</b>	<b>1 000</b>

8-channel pipettes			
10µL	120µL	300µL	1200µL
<b>600</b>	✓	✓	✓



**DEERWELL MICROPLATE**  
**DOMINO**  
PN: 186009597

# WHEATON® 500 µL 96-well U-bottom medium µLplate



**Manufacturer:**  
DWK Life Sciences

**Part number:**  
07-2100-B

1-channel pipettes					
10µL	120µL	300µL	1000µL	5mL	10mL
✓	✓	✓	250	🧪	✗

8-channel pipettes			
10µL	120µL	300µL	1200µL
✓	✓	✓	✓



DEEPWELL MICROPLATE  
DOMINO  
PN: 186009597

# Zeba™ Spin Desalting Plate



**Manufacturer:**  
Thermo Scientific

**Part number:**  
A57768

1-channel pipettes					
10µL	120µL	300µL	1000µL	5mL	10mL
✓	✓	✓	<b>200</b>	<b>150</b>	<b>300</b>

8-channel pipettes			
10µL	120µL	300µL	1200µL
<b>150</b>	✓	✓	✓



**DEERWELL MICROPLATE**  
**DOMINO**  
PN: 186009597

Ordering product number

**186009596**

OneLab reference: [218.2901]

## STORAGE PLATE DOMINO



The Storage Plate Domino is specifically designed to directly hold certain types of deepwell plates but also racks of tubes and vials used for sample and reagent storage.

**SEE THIS DOMINO  
ON OUR E-SHOP**

# 1.4mL Nova Biostorage tube into Matrix™ 2D rack



**Manufacturer:**  
Thermo Scientific

**Part number:**  
MP226RP

1-channel pipettes					
10µL	120µL	300µL	1000µL	5mL	10mL
✓	50	✓	600	600	800

8-channel pipettes			
10µL	120µL	300µL	1200µL
250	50	✓	✓



STORAGE PLATE  
DOMINO  
PN: 186009596



# 4 mL aluminum 24-well reaction block



**Manufacturer:**  
Analytical Sales  
& Services, Inc.

**Part number:**  
24015

1-channel pipettes					
10 $\mu$ L	120 $\mu$ L	300 $\mu$ L	1000 $\mu$ L	5mL	10mL
✓	✓	✓	✓	2 500	🧪

8-channel pipettes			
10 $\mu$ L	120 $\mu$ L	300 $\mu$ L	1200 $\mu$ L
✗	✗	✗	✗



STORAGE PLATE  
DOMINO  
PN: 186009596

# 96-well photoredox block assembly



**Manufacturer:**  
Analytical Sales  
& Services, Inc.

**Part number:**  
96973

1-channel pipettes					
10 $\mu$ L	120 $\mu$ L	300 $\mu$ L	1000 $\mu$ L	5mL	10mL
<b>200</b>	✓	✓	<b>400</b>	<b>400</b>	<b>600</b>

8-channel pipettes			
10 $\mu$ L	120 $\mu$ L	300 $\mu$ L	1200 $\mu$ L
<b>200</b>	✓	✓	✓



**STORAGE PLATE**  
**DOMINO**  
PN: 186009596

# Abgene™ 2.2mL 96-well Deepwell Sample Plate



**Manufacturer:**  
Thermo Scientific

**Part number:**  
AB-0661

1-channel pipettes					
10µL	120µL	300µL	1000µL	5mL	10mL
✓	✓	✓	✓	✓	✓

8-channel pipettes			
10µL	120µL	300µL	1200µL
600	✓	✓	✓



STORAGE PLATE  
DOMINO  
PN: 186009596

# Abgene™ 96 Well 1.2mL Deepwell Plate



**Manufacturer:**  
Thermo Scientific

**Part number:**  
AB1127

1-channel pipettes					
10µL	120µL	300µL	1000µL	5mL	10mL
✓	✓	✓	800	✓	✓

8-channel pipettes			
10µL	120µL	300µL	1200µL
300	✓	✓	200



STORAGE PLATE  
DOMINO  
PN: 186009596

# Agilent 2 mL 12x32mm screw-top vial in 54x vial plate



**Manufacturer:**  
Agilent Technologies

**Part number:**  
5182-0715

1-channel pipettes					
10 $\mu$ L	120 $\mu$ L	300 $\mu$ L	1000 $\mu$ L	5mL	10mL
✓	✓	✓	1 000	🧪	🧪

8-channel pipettes			
10 $\mu$ L	120 $\mu$ L	300 $\mu$ L	1200 $\mu$ L
✗	✗	✗	✗



STORAGE PLATE  
DOMINO  
PN: 186009596

# Agilent 96-well plate, 2.2 mL



**Manufacturer:**  
Agilent Technologies

**Part number:**  
5043-9300



1-channel pipettes					
10 $\mu$ L	120 $\mu$ L	300 $\mu$ L	1000 $\mu$ L	5mL	10mL
✓	✓	✓	✓	<b>300</b>	<b>750</b>

8-channel pipettes			
10 $\mu$ L	120 $\mu$ L	300 $\mu$ L	1200 $\mu$ L
<b>300</b>	✓	✓	✓



**STORAGE PLATE**  
**DOMINO**  
PN: 186009596

# ArcticWhite, 73 mL 4-column reservoir



**Manufacturer:**  
ArcticWhite LLC

**Part number:**  
AWLS-S30051

## 1-channel pipettes

10 $\mu$ L	120 $\mu$ L	300 $\mu$ L	1000 $\mu$ L	5mL	10mL
✓	✓	✓	✓	✓	✓

## 8-channel pipettes

10 $\mu$ L	120 $\mu$ L	300 $\mu$ L	1200 $\mu$ L
✓	✓	✓	✓



STORAGE PLATE  
DOMINO  
PN: 186009596

# Azenta 0.9 mL external thread dual-coded tube in 96x rack



**Manufacturer:**  
Azenta Life Sciences

**Part number:**  
68-1001-11

1-channel pipettes					
10 $\mu$ L	120 $\mu$ L	300 $\mu$ L	1000 $\mu$ L	5mL	10mL
✓	✓	✓	600	🧪	🧪

8-channel pipettes			
10 $\mu$ L	120 $\mu$ L	300 $\mu$ L	1200 $\mu$ L
500	✓	✓	✓



STORAGE PLATE  
DOMINO  
PN: 186009596



# Azenta 1 mL external thread tri-coded tube in 96x rack



**Manufacturer:**  
Azenta Life Sciences

**Part number:**  
68-1003-01

1-channel pipettes					
10 $\mu$ L	120 $\mu$ L	300 $\mu$ L	1000 $\mu$ L	5mL	10mL
✓	200	200	700	700	

8-channel pipettes			
10 $\mu$ L	120 $\mu$ L	300 $\mu$ L	1200 $\mu$ L
600	200	200	200



**STORAGE PLATE**  
**DOMINO**  
PN: 186009596

# Azenta 1.5 mL external thread 2D tube in 48x rack



**Manufacturer:**  
Azenta Life Sciences

**Part number:**  
65-7667

1-channel pipettes					
10 $\mu$ L	120 $\mu$ L	300 $\mu$ L	1000 $\mu$ L	5mL	10mL
✓	✓	✓	✓	✓	✓

8-channel pipettes			
10 $\mu$ L	120 $\mu$ L	300 $\mu$ L	1200 $\mu$ L
✗	✗	✗	✗



**STORAGE PLATE**  
**DOMINO**  
PN: 186009596

# Azenta 1.9 mL external thread 2D tube in 48x rack



**Manufacturer:**  
Azenta Life Sciences

**Part number:**  
65-7647

1-channel pipettes					
10 $\mu$ L	120 $\mu$ L	300 $\mu$ L	1000 $\mu$ L	5mL	10mL
✓	✓	✓	✓	✓	<b>300</b>

8-channel pipettes			
10 $\mu$ L	120 $\mu$ L	300 $\mu$ L	1200 $\mu$ L
✗	✗	✗	✗



**STORAGE PLATE**  
**DOMINO**  
PN: 186009596

# Azenta 3.8 mL external thread tri-coded tube in 48x rack



**Manufacturer:**  
Azenta Life Sciences

**Part number:**  
65-7515

## 1-channel pipettes

10 $\mu$ L	120 $\mu$ L	300 $\mu$ L	1000 $\mu$ L	5mL	10mL
✓	✓	✓	200	2 900	3 800

## 8-channel pipettes

10 $\mu$ L	120 $\mu$ L	300 $\mu$ L	1200 $\mu$ L
✗	✗	✗	✗



**STORAGE PLATE**  
**DOMINO**  
PN: 186009596

# Eppendorf 0.5 mL 96-deep well protein LoBind® plate, yellow frame



**Manufacturer:**  
Eppendorf

**Part number:**  
0030504119



1-channel pipettes					
10µL	120µL	300µL	1000µL	5mL	10mL
✓	✓	✓	✓	✓	<b>300</b>

8-channel pipettes			
10µL	120µL	300µL	1200µL
<b>300</b>	✓	✓	✓



**STORAGE PLATE**  
**DOMINO**  
PN: 186009596

# Eppendorf 2 mL 96-square deep well plate, yellow frame



**Manufacturer:**  
Eppendorf

**Part number:**  
0030501314



Compatible with  
Microplate  
Gripper

## 1-channel pipettes

10 $\mu$ L	120 $\mu$ L	300 $\mu$ L	1000 $\mu$ L	5mL	10mL
✓	✓	✓	✓	<b>700</b>	<b>1 300</b>

## 8-channel pipettes

10 $\mu$ L	120 $\mu$ L	300 $\mu$ L	1200 $\mu$ L
<b>500</b>	✓	✓	✓



**STORAGE PLATE**  
**DOMINO**  
PN: 186009596

# Eppendorf™ Deepwell™ Plates 96



**Manufacturer:**  
Eppendorf

**Part number:**  
951033308

1-channel pipettes					
10µL	120µL	300µL	1000µL	5mL	10mL
✓	✓	✓	500	500	700

8-channel pipettes			
10µL	120µL	300µL	1200µL
300	✓	✓	✓



**STORAGE PLATE**  
**DOMINO**  
PN: 186009596

# FluidX 1.9 mL external thread 2D cryotube in 48x rack



**Manufacturer:**  
Azenta Life Sciences

**Part number:**  
65-7643

1-channel pipettes					
10 $\mu$ L	120 $\mu$ L	300 $\mu$ L	1000 $\mu$ L	5mL	10mL
✓	✓	✓	✓	✓	<b>500</b>

8-channel pipettes			
10 $\mu$ L	120 $\mu$ L	300 $\mu$ L	1200 $\mu$ L
✗	✗	✗	✗



**STORAGE PLATE**  
**DOMINO**  
PN: 186009596



# Matrix™ 0.5 mL V-bottom 2D screw-top tube in 96x rack



**Manufacturer:**  
Thermo Scientific

**Part number:**  
3744-BR

1-channel pipettes					
10µL	120µL	300µL	1000µL	5mL	10mL
✓	✓	✓	300	300	400

8-channel pipettes			
10µL	120µL	300µL	1200µL
300	✓	✓	✓



STORAGE PLATE  
DOMINO  
PN: 186009596

# Matrix™ 0.75 mL blank storage tube in 96x rack



**Manufacturer:**  
Thermo Scientific

**Part number:**  
4272

1-channel pipettes					
10µL	120µL	300µL	1000µL	5mL	10mL
✓	✓	✓	300	🚫	🚫

8-channel pipettes			
10µL	120µL	300µL	1200µL
200	✓	✓	✓



STORAGE PLATE  
DOMINO  
PN: 186009596

# Matrix 1.0 mL Deepwell Storage Blocks



**Manufacturer:**  
Thermo Scientific

**Part number:**  
4211-11

1-channel pipettes					
10 $\mu$ L	120 $\mu$ L	300 $\mu$ L	1000 $\mu$ L	5mL	10mL
✓	✓	✓	500	400	600

8-channel pipettes			
10 $\mu$ L	120 $\mu$ L	300 $\mu$ L	1200 $\mu$ L
200	✓	✓	✓



STORAGE PLATE  
**DOMINO**  
PN: 186009596

# Matrix™ 1 mL V-bottom 2D screw-top tube in 96x rack



**Manufacturer:**  
Thermo Scientific

**Part number:**  
3741-BR

1-channel pipettes					
10µL	120µL	300µL	1000µL	5mL	10mL
✓	30	20	600	600	850

8-channel pipettes			
10µL	120µL	300µL	1200µL
500	30	20	30



**STORAGE PLATE**  
**DOMINO**  
PN: 186009596

# Matrix™ 1.4 mL 2D barcoded open-top tube in 96x rack



**Manufacturer:**  
Thermo Scientific

**Part number:**  
3791

1-channel pipettes					
10µL	120µL	300µL	1000µL	5mL	10mL
✓	70	50	700	700	9 004

8-channel pipettes			
10µL	120µL	300µL	1200µL
300	70	50	✓



STORAGE PLATE  
DOMINO  
PN: 186009596

# Matrix™ 1.4 mL alphanumeric storage tube in 96x rack



**Manufacturer:**  
Thermo Scientific

**Part number:**  
4251

1-channel pipettes					
10µL	120µL	300µL	1000µL	5mL	10mL
✓	100	100	650	🚫	🚫

8-channel pipettes			
10µL	120µL	300µL	1200µL
500	100	100	✓



**STORAGE PLATE**  
**DOMINO**  
PN: 186009596

# Matrix™ ScrewTop Tri-coded Tubes into 96 positions rack



**Manufacturer:**  
Thermo Scientific

**Part number:**  
3742-WP1D-BR



Compatible with  
Microplate  
Gripper

1-channel pipettes					
10 $\mu$ L	120 $\mu$ L	300 $\mu$ L	1000 $\mu$ L	5mL	10mL
✓	✓	✓	650	550	800

8-channel pipettes			
10 $\mu$ L	120 $\mu$ L	300 $\mu$ L	1200 $\mu$ L
✓	✓	✓	40





STORAGE PLATE  
DOMINO  
PN: 186009596

# Milian, 1.2 mL transfer tube in Hitplate™ 96x rack



**Manufacturer:**  
Milian

**Part number:**  
605300

1-channel pipettes					
10µL	120µL	300µL	1000µL	5mL	10mL
✓	✓	100	600		

8-channel pipettes			
10µL	120µL	300µL	1200µL
✓	✓	100	700



**STORAGE PLATE**  
**DOMINO**  
PN: 186009596



# Riplate® Medio 1mL Deepwell Plate



**Manufacturer:**  
Carl Roth

**Part number:**  
TC22.1

1-channel pipettes					
10µL	120µL	300µL	1000µL	5mL	10mL
✓	✓	✓	✓	✓	✓

8-channel pipettes			
10µL	120µL	300µL	1200µL
<b>450</b>	✓	✓	✓



**STORAGE PLATE**  
**DOMINO**  
PN: 186009596

# Riplate® 2mL Deepwell Plate



**Manufacturer:**  
Carl Roth

**Part number:**  
EN07.1

1-channel pipettes					
10µL	120µL	300µL	1000µL	5mL	10mL
✓	✓	✓	✓	<b>800</b>	<b>1 200</b>

8-channel pipettes			
10µL	120µL	300µL	1200µL
<b>600</b>	✓	✓	✓



**STORAGE PLATE**  
**DOMINO**  
PN: 186009596

# Waters 2 mL 96-square well collection plate, cut corner A1/H1



SEE THIS CONSUMABLE  
ON OUR E-SHOP

**Manufacturer:**  
Waters

**Part number:**  
WAT058958

1-channel pipettes					
10 $\mu$ L	120 $\mu$ L	300 $\mu$ L	1000 $\mu$ L	5mL	10mL
✓	✓	✓	✓	<b>300</b>	<b>850</b>

8-channel pipettes			
10 $\mu$ L	120 $\mu$ L	300 $\mu$ L	1200 $\mu$ L
✓	✓	✓	✓



STORAGE PLATE  
**DOMINO**  
PN: 186009596

# Waters 2 mL 96-square well collection plate, cut corner H1



SEE THIS CONSUMABLE  
ON OUR E-SHOP

**Manufacturer:**  
Waters

**Part number:**  
186002482



Compatible with  
Microplate  
Gripper

## 1-channel pipettes

10 $\mu$ L	120 $\mu$ L	300 $\mu$ L	1000 $\mu$ L	5mL	10mL
✓	✓	✓	✓	<b>300</b>	<b>850</b>

## 8-channel pipettes

10 $\mu$ L	120 $\mu$ L	300 $\mu$ L	1200 $\mu$ L
✓	✓	✓	✓



STORAGE PLATE  
**DOMINO**  
PN: 186009596

# Waters 700 $\mu$ L 96-round well collection plate



SEE THIS CONSUMABLE  
ON OUR E-SHOP

**Manufacturer:**  
Waters

**Part number:**  
186005837



1-channel pipettes					
10 $\mu$ L	120 $\mu$ L	300 $\mu$ L	1000 $\mu$ L	5mL	10mL
✓	✓	✓	100	100	

8-channel pipettes			
10 $\mu$ L	120 $\mu$ L	300 $\mu$ L	1200 $\mu$ L
200	✓	✓	✓



STORAGE PLATE  
DOMINO  
PN: 186009596

# Waters 800 $\mu$ L 96-round well collection plate



SEE THIS CONSUMABLE  
ON OUR E-SHOP

**Manufacturer:**  
Waters

**Part number:**  
186002481



1-channel pipettes					
10 $\mu$ L	120 $\mu$ L	300 $\mu$ L	1000 $\mu$ L	5mL	10mL
✓	✓	✓	50	200	400

8-channel pipettes			
10 $\mu$ L	120 $\mu$ L	300 $\mu$ L	1200 $\mu$ L
200	✓	✓	✓



STORAGE PLATE  
**DOMINO**  
PN: 186009596

# Waters GlycoWorks™ 600 µL tubes in 96x plate



**SEE THIS CONSUMABLE  
ON OUR E-SHOP**

**Manufacturer:**  
Waters

**Part number:**  
186007988-3



1-channel pipettes					
10µL	120µL	300µL	1000µL	5mL	10mL
<b>120</b>	✓	✓	<b>300</b>	<b>300</b>	

8-channel pipettes			
10µL	120µL	300µL	1200µL
<b>120</b>	✓	✓	<b>300</b>



**STORAGE PLATE**  
**DOMINO**  
PN: 186009596

# Waters QuanRecovery™ 700 µL 96-well plate



**SEE THIS CONSUMABLE  
ON OUR E-SHOP**

**Manufacturer:**  
Waters

**Part number:**  
186009185



1-channel pipettes					
10µL	120µL	300µL	1000µL	5mL	10mL
✓	✓	✓	50	200	400

8-channel pipettes			
10µL	120µL	300µL	1200µL
200	✓	✓	✓



**STORAGE PLATE**  
**DOMINO**  
PN: 186009596



# Whatman® 96 wells, 2 mL uniplate



**Manufacturer:**  
Whatman

**Part number:**  
7701-5200

1-channel pipettes					
10µL	120µL	300µL	1000µL	5mL	10mL
✓	✓	✓	✓	<b>500</b>	<b>1 000</b>

8-channel pipettes			
10µL	120µL	300µL	1200µL
<b>600</b>	✓	✓	✓



**STORAGE PLATE**  
**DOMINO**  
PN: 186009596

# Zeba™ Spin Desalting Plate



**Manufacturer:**  
Thermo Scientific

**Part number:**  
A57768

1-channel pipettes					
10 $\mu$ L	120 $\mu$ L	300 $\mu$ L	1000 $\mu$ L	5mL	10mL
✓	✓	✓	<b>200</b>	<b>100</b>	<b>300</b>

8-channel pipettes			
10 $\mu$ L	120 $\mu$ L	300 $\mu$ L	1200 $\mu$ L
<b>150</b>	✓	✓	✓



**STORAGE PLATE**  
**DOMINO**  
PN: 186009596

Ordering product number

**186010088**

OneLab reference: [218.2212]

## 96-PCR PLATE DOMINO



The 96-PCR Plate Domino is designed to hold an array of PCR-type plates with or without skirts thanks to its snug-fitting 96x format pockets.

**SEE THIS DOMINO  
ON OUR E-SHOP**

# Axygen® 96-well PCR white microplate



**Manufacturer:**  
Starlab

**Part number:**  
PCR-96-LC480-W-NF

1-channel pipettes					
10µL	120µL	300µL	1000µL	5mL	10mL
✓	✓	✓	✓	40	60

8-channel pipettes			
10µL	120µL	300µL	1200µL
✓	✓	✓	✓



**96-PCR PLATE DOMINO**  
PN: 186010088

# Eppendorf twin.tec® 96-well semi-skirted PCR plate



**Manufacturer:**  
Eppendorf

**Part number:**  
0030128575

1-channel pipettes					
10µL	120µL	300µL	1000µL	5mL	10mL
✓	✓	✓	✓	✗	✗

  

8-channel pipettes			
10µL	120µL	300µL	1200µL
✓	✓	✓	✓



**96-PCR PLATE DOMINO**  
PN: 186010088

# FrameStar® break-a-way PCR plate in 96x FrameStrip® adapter

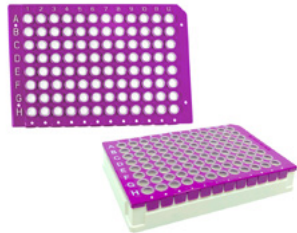

**Manufacturer:**  
Azenta Life Sciences

**Part number:**  
4ti-1000/P

1-channel pipettes					
10µL	120µL	300µL	1000µL	5mL	10mL
✓	✓	✓	✓	✗	✗

  

8-channel pipettes			
10µL	120µL	300µL	1200µL
✓	✓	✓	✓



**96-PCR PLATE DOMINO**  
PN: 186010088

# FrameStrip® 8-well PCR tube strip in 96x FrameStrip® adapter

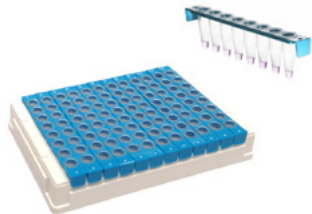

**Manufacturer:**  
Azenta Life Sciences

**Part number:**  
4ti-0786/B

1-channel pipettes					
10µL	120µL	300µL	1000µL	5mL	10mL
✓	✓	✓	✓	✗	✗

8-channel pipettes			
10µL	120µL	300µL	1200µL
✓	✓	✓	✓



**96-PCR PLATE DOMINO**  
PN: 186010088

# MicroAmp™ 0.2 mL Fast Optical 96-well semi-skirted reaction plate



**Manufacturer:**  
Thermo Scientific

**Part number:**  
4346907

1-channel pipettes					
10µL	120µL	300µL	1000µL	5mL	10mL
✓	✓	✓	✓	⚠	⚠

8-channel pipettes			
10µL	120µL	300µL	1200µL
✓	✓	✓	✓



**96-PCR PLATE DOMINO**  
PN: 186010088



# MicroAmp™ 0.3 mL optical 96-well semi-skirted reaction plate



**Manufacturer:**  
Applied Biosystems

**Part number:**  
N8010560

1-channel pipettes					
10µL	120µL	300µL	1000µL	5mL	10mL
✓	✓	✓	<b>100</b>	🚫	🚫

8-channel pipettes			
10µL	120µL	300µL	1200µL
✓	✓	✓	✓



**96-PCR PLATE DOMINO**  
PN: 186010088

# MicroAmp™ EnduraPlate™ 0.3 mL optical 96-well reaction plate w/ barcode



**Manufacturer:**  
Applied Biosystems

**Part number:**  
4483354

1-channel pipettes					
10µL	120µL	300µL	1000µL	5mL	10mL
✓	✓	✓	✓	⚠	⚠

8-channel pipettes			
10µL	120µL	300µL	1200µL
✓	✓	✓	✓



**96-PCR PLATE DOMINO**  
PN: 186010088

# MicroAmp™ EnduraPlate™ Optical 96-Well Fast Clear Reaction Plates with Barcode



**Manufacturer:**  
Thermo Scientific

**Part number:**  
4483485

1-channel pipettes					
10µL	120µL	300µL	1000µL	5mL	10mL
✓	✓	✓	✓	20	30

8-channel pipettes			
10µL	120µL	300µL	1200µL
✓	✓	✓	✓



**96-PCR PLATE DOMINO**  
PN: 186010088

# Multiply<sup>®</sup> 96-well non-skirted PCR plate



**Manufacturer:**  
Sarstedt

**Part number:**  
72.1978

1-channel pipettes					
10 $\mu$ L	120 $\mu$ L	300 $\mu$ L	1000 $\mu$ L	5mL	10mL
✓	✓	✓	✓	✗	✗

8-channel pipettes			
10 $\mu$ L	120 $\mu$ L	300 $\mu$ L	1200 $\mu$ L
✓	✓	✓	✓



**96-PCR PLATE DOMINO**  
PN: 186010088

# Roche LightCycler® 480 white 96-well plate



**Manufacturer:**  
Roche

**Part number:**  
04729692001

1-channel pipettes					
10µL	120µL	300µL	1000µL	5mL	10mL
✓	✓	✓	✓	✗	✗

8-channel pipettes			
10µL	120µL	300µL	1200µL
✓	✓	✓	✓



**96-PCR PLATE DOMINO**  
PN: 186010088

# TempAssure® 0.2 mL 8-tube strip in Vari-Plate™ 96x frame



**Manufacturer:**  
USA Scientific, Inc.

**Part number:**  
1402-2500

1-channel pipettes					
10µL	120µL	300µL	1000µL	5mL	10mL
✓	✓	✓	<b>100</b>	🚫	🚫

8-channel pipettes			
10µL	120µL	300µL	1200µL
✓	✓	✓	✓

## IMPORTANT

When setting up the TempAssure® 0.2 mL 8-tube strip(s) in Vari-Plate™ 96x frame into the 96-PCR Plate Domino, it is recommended to first place the empty frame in the Domino, ensuring it is firmly inserted into the support.

Then, the TempAssure® 0.2 mL 8-tube strip(s) can be individually loaded into any of the 12x column slots of the frame as required and in a clean way (using gloves), making sure they are properly inserted.



96-PCR PLATE DOMINO  
PN: 186010088

# Thermo Scientific™ 96-well non-skirted PCR plate



**Manufacturer:**  
Thermo Scientific

**Part number:**  
AB0600

1-channel pipettes					
10 $\mu$ L	120 $\mu$ L	300 $\mu$ L	1000 $\mu$ L	5mL	10mL
✓	✓	✓	✓	✗	✗

8-channel pipettes			
10 $\mu$ L	120 $\mu$ L	300 $\mu$ L	1200 $\mu$ L
✓	✓	✓	✓



**96-PCR PLATE DOMINO**  
PN: 186010088

# Thermo Scientific™ Armadillo™ 96-well PCR strip plate



**Manufacturer:**  
Thermo Scientific

**Part number:**  
AB2796

1-channel pipettes					
10 $\mu$ L	120 $\mu$ L	300 $\mu$ L	1000 $\mu$ L	5mL	10mL
✓	✓	✓	✓	⚠	⚠

8-channel pipettes			
10 $\mu$ L	120 $\mu$ L	300 $\mu$ L	1200 $\mu$ L
✓	✓	✓	✓



**96-PCR PLATE DOMINO**  
PN: 186010088



Ordering product number

**186010325**

OneLab reference: [218.5191]

## PCR CARTRIDGE DOMINO



The PCR Cartridge Domino is designed to securely hold a specific PCR-type plate in place during automated pipetting steps where tips will get «stuck» inside the consumable due to the design of the plate. This Domino design ensures that the plate doesn't move during the pipetting steps and can't get inadvertently picked up by the Andrew+ instrument after pipetting. Note: the «dispense from the bottom» option must be selected in OneLab when working with this consumable.

**SEE THIS DOMINO  
ON OUR E-SHOP**

# QX ONE ddPCR GCR96 cartridge plate



**Manufacturer:**  
Bio-Rad Laboratories

**Part number:**  
12006858

1-channel pipettes					
10 $\mu$ L	120 $\mu$ L	300 $\mu$ L	1000 $\mu$ L	5mL	10mL
✓	✓	✓	🚫	🚫	🚫

8-channel pipettes			
10 $\mu$ L	120 $\mu$ L	300 $\mu$ L	1200 $\mu$ L
✓	✓	✓	🚫



**PCR CARTRIDGE DOMINO**  
PN: 186010325

Ordering product number

**186010172**

OneLab reference: [218.3361]

## WES AND JESS PLATE DOMINO



The Wes and Jess Plate Domino is specifically designed to hold the plates bearing the same name.

**SEE THIS DOMINO  
ON OUR E-SHOP**

# ProteinSimple, Wes/Jess plate



**Manufacturer:**  
ProteinSimple

**Part number:**  
PS-PP03

1-channel pipettes					
10 $\mu$ L	120 $\mu$ L	300 $\mu$ L	1000 $\mu$ L	5mL	10mL
✓	✓	✓	✓	⚠	⚠

8-channel pipettes			
10 $\mu$ L	120 $\mu$ L	300 $\mu$ L	1200 $\mu$ L
✗	✗	✗	✗



**WES AND JESS  
PLATE DOMINO**  
PN: 186010172

Ordering product number

**186010284**

OneLab reference: [218.4341]

## NON-ANSI PLATE DOMINO



The Non-ANSI Plate Domino is specifically designed to hold plates that are not compliant with ANSI standard microplate footprint dimensions.

[SEE THIS DOMINO  
ON OUR E-SHOP](#)

# Nunc™ 0.3 mL 96-MicroWell™ plate



**Manufacturer:**  
Thermo Scientific

**Part number:**  
442587

1-channel pipettes					
10 $\mu$ L	120 $\mu$ L	300 $\mu$ L	1000 $\mu$ L	5mL	10mL
✓	✓	✓	✓	⚠	⚠

8-channel pipettes			
10 $\mu$ L	120 $\mu$ L	300 $\mu$ L	1200 $\mu$ L
✓	✓	✓	✓



**NON-ANSI**  
**PLATE DOMINO**  
PN: 186010284

Ordering product number

**186010306**

OneLab reference: [218.5611]

## LANDING PAD MICROPLATE DOMINO



The Landing Pad Microplate Domino is a specifically engineered Microplate Domino that is designed to allow robotic arms other than Andrew+ to grab plates found inside it from their «long edge».

[SEE THIS DOMINO  
ON OUR E-SHOP](#)

# Greiner, 96-well PS F-bottom clear microplate



**Manufacturer:**  
Greiner Bio-One

**Part number:**  
655101



1-channel pipettes					
10 $\mu$ L	120 $\mu$ L	300 $\mu$ L	1000 $\mu$ L	5mL	10mL
✓	✓	✓	✓	⚠	⚠

8-channel pipettes			
10 $\mu$ L	120 $\mu$ L	300 $\mu$ L	1200 $\mu$ L
✓	✓	✓	✓



LANDING PAD  
MICROPLATE DOMINO  
PN: 186010306



Ordering product number

**186010310**

OneLab reference: [218.5251]

## 100-WELL HONEYCOMB PLATE DOMINO

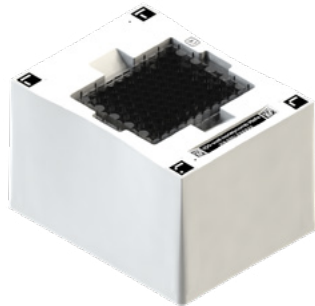

The 100-well HoneyComb Plate Domino is specifically designed to hold non-standard, small-format 100-well plates that have a «honeycomb» configuration where the wells are not aligned.

**SEE THIS DOMINO  
ON OUR E-SHOP**

# Bioscreen Sterile Honeycomb Plates



**Manufacturer:**  
Thermo Scientific

**Part number:**  
9502550

1-channel pipettes					
10 $\mu$ L	120 $\mu$ L	300 $\mu$ L	1000 $\mu$ L	5mL	10mL
✓	✓	✓	✓	✓	⚠

8-channel pipettes			
10 $\mu$ L	120 $\mu$ L	300 $\mu$ L	1200 $\mu$ L
✗	✗	✗	✗



100-WELL HONEYCOMB  
PLATE DOMINO  
PN: 186010310

Ordering product number

**186010322**

OneLab reference: [218.5371]

## METALLIC OEM PLATE DOMINO



The Metallic OEM Plate Domino is a custom-designed Domino for holding up to 6 metallic reaction vessels.

**SEE THIS DOMINO  
ON OUR E-SHOP**

# Metallic reaction vessel in 2x3 position holder

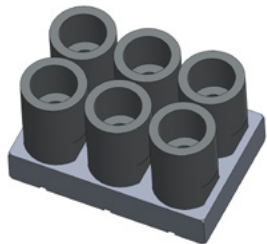

**Manufacturer:**  
OEM

**Part number:**  
N/A

1-channel pipettes					
10 $\mu$ L	120 $\mu$ L	300 $\mu$ L	1000 $\mu$ L	5mL	10mL
✓	✓	✓	✓	✓	✓

8-channel pipettes			
10 $\mu$ L	120 $\mu$ L	300 $\mu$ L	1200 $\mu$ L
✗	✗	✗	✗



**METALLIC OEM PLATE**  
**DOMINO**  
PN: 186010322

Ordering product number

**186010195**

OneLab reference: [218.3571]

## TILTED MICROPLATE DOMINO



The Tilted Microplate Domino is designed to hold a growing array of microplates. It's lightly tilted design holds microplates in place at a small descending angle from back to front (short edge), thus minimizing dead-volumes. The Andrew+ robot detects the use of this Domino and adapts dispensing and aspirating steps accordingly, specifically choosing to dispense towards the top of the wells and aspirating from their bottom corner for optimal volume recovery.

**SEE THIS DOMINO  
ON OUR E-SHOP**

# 24-well plate with glass bottom



**Manufacturer:**  
Cellvis

**Part number:**  
P24-1.5H-N

1-channel pipettes					
10 $\mu$ L	120 $\mu$ L	300 $\mu$ L	1000 $\mu$ L	5mL	10mL
✓	✓	✓	✓	✓	✓

8-channel pipettes			
10 $\mu$ L	120 $\mu$ L	300 $\mu$ L	1200 $\mu$ L
✗	✗	✗	✗



TILTED MICROPLATE  
DOMINO  
PN: 186010195

# 96-well plate with glass bottom



**Manufacturer:**  
Cellvis

**Part number:**  
P96-1.5H-N

1-channel pipettes					
10 $\mu$ L	120 $\mu$ L	300 $\mu$ L	1000 $\mu$ L	5mL	10mL
✓	✓	✓	✓	✓	✗

  

8-channel pipettes			
10 $\mu$ L	120 $\mu$ L	300 $\mu$ L	1200 $\mu$ L
✓	✓	✓	✓



TILTED MICROPLATE  
DOMINO  
PN: 186010195

# CELLSTAR® 24-well cell culture plate

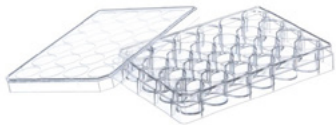

**Manufacturer:**  
Greiner Bio-One

**Part number:**  
662160

1-channel pipettes					
10µL	120µL	300µL	1000µL	5mL	10mL
✓	✓	✓	✓	✓	✓

8-channel pipettes			
10µL	120µL	300µL	1200µL
✗	✗	✗	✗



TILTED MICROPLATE  
DOMINO  
PN: 186010195



# Corning® 96-well Half Area, Glass Bottom Microplate



**Manufacturer:**  
Corning Inc.

**Part number:**  
4580

1-channel pipettes					
10 $\mu$ L	120 $\mu$ L	300 $\mu$ L	1000 $\mu$ L	5mL	10mL
✓	✓	✓	✓	✗	✗

8-channel pipettes			
10 $\mu$ L	120 $\mu$ L	300 $\mu$ L	1200 $\mu$ L
✓	✓	✓	✓



TILTED MICROPLATE  
DOMINO  
PN: 186010195

# Corning® CellBIND® 360 µL 96-well clear bottom black microplate



**Manufacturer:**  
Corning Inc.

**Part number:**  
3340

1-channel pipettes					
10µL	120µL	300µL	1000µL	5mL	10mL
✓	✓	✓	✓	⚠	⚠

8-channel pipettes			
10µL	120µL	300µL	1200µL
✓	✓	✓	✓



**TILTED MICROPLATE**  
**DOMINO**  
PN: 186010195

# Falcon® 6-well cell culture plate, tilted wells



**Manufacturer:**  
Corning Inc.

**Part number:**  
353224

1-channel pipettes					
10µL	120µL	300µL	1000µL	5mL	10mL
✓	✓	✓	✓	✓	✓

8-channel pipettes			
10µL	120µL	300µL	1200µL
✗	✗	✗	✗



TILTED MICROPLATE  
DOMINO  
PN: 186010195

# ibidi, 96-well ibiTreat black $\mu$ -Plate w/ polymer coverslip bottom



**Manufacturer:**  
ibidi

**Part number:**  
89626

## 1-channel pipettes

10 $\mu$ L	120 $\mu$ L	300 $\mu$ L	1000 $\mu$ L	5mL	10mL
✓	✓	✓	✓	✓	✓

## 8-channel pipettes

10 $\mu$ L	120 $\mu$ L	300 $\mu$ L	1200 $\mu$ L
✓	✓	✓	✓



TILTED MICROPLATE  
DOMINO  
PN: 186010195

# Nunc™ Edge™ 96-well cell culture-treated microplate



**Manufacturer:**  
Thermo Scientific

**Part number:**  
167425

1-channel pipettes					
10µL	120µL	300µL	1000µL	5mL	10mL
✓	✓	✓	✓	⚠	⚠

  

8-channel pipettes			
10µL	120µL	300µL	1200µL
✓	✓	✓	✓



TILTED MICROPLATE  
DOMINO  
PN: 186010195

# TPP 12-well tissue culture test plate

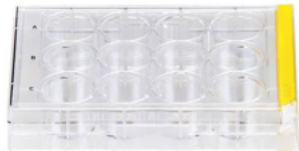

**Manufacturer:**  
TPP AG

**Part number:**  
92412

1-channel pipettes					
10 $\mu$ L	120 $\mu$ L	300 $\mu$ L	1000 $\mu$ L	5mL	10mL
✓	✓	✓	✓	✓	✓

8-channel pipettes			
10 $\mu$ L	120 $\mu$ L	300 $\mu$ L	1200 $\mu$ L
✗	✗	✗	✗



TILTED MICROPLATE  
DOMINO  
PN: 186010195

Ordering product number

**186010200**

OneLab reference: [218.4001]

## LONG EDGE TILT DEEPWELL DOMINO



The Long Edge Tilt Domino is designed to hold a growing array of consumables used for various applications. It's lightly tilted design holds plates and reservoirs in place at a small descending angle from left to right (long edge), thus minimizing dead-volumes. The Andrew+ robot detects the use of this Domino and adapts dispensing and aspirating steps accordingly, specifically choosing to dispense towards the sides of the wells and aspirating from their bottom corner for optimal volume recovery.

**SEE THIS DOMINO  
ON OUR E-SHOP**

# ArcticWhite, 290 mL single cavity reservoir



**Manufacturer:**  
ArcticWhite LLC

**Part number:**  
AWLS-S30017

## 1-channel pipettes

10 $\mu$ L	120 $\mu$ L	300 $\mu$ L	1000 $\mu$ L	5mL	10mL
✓	✓	✓	✓	✓	✓

## 8-channel pipettes

10 $\mu$ L	120 $\mu$ L	300 $\mu$ L	1200 $\mu$ L
✓	✓	✓	✓



LONG EDGE TILT  
DEERWELL DOMINO  
PN: 186010200



# Axygen® 96 V-bottom single well reservoir



**Manufacturer:**  
Corning Inc.

**Part number:**  
RES-SW96-HP-SI

1-channel pipettes					
10µL	120µL	300µL	1000µL	5mL	10mL
✓	✓	✓	✓	✓	✓

8-channel pipettes			
10µL	120µL	300µL	1200µL
✓	✓	✓	✓



LONG EDGE TILT  
DEEPWELL DOMINO  
PN: 186010200

Ordering product number

**186009613**

OneLab reference: [218.2182]

## 8-CHANNEL PIPETTE RESERVOIR DOMINO



The 8-channel Pipette Reservoir Domino is specifically designed to hold 2x 10mL reservoirs in a single Domino location while providing minimal dead volume and 8-channel pipette compatibility.

**SEE THIS DOMINO  
ON OUR E-SHOP**

# INTEGRA 10 mL multichannel reservoir



**Manufacturer:**  
INTEGRA Biosciences

**Part number:**  
4332

1-channel pipettes					
10 $\mu$ L	120 $\mu$ L	300 $\mu$ L	1000 $\mu$ L	5mL	10mL
✓	✓	✓	✓	✓	✓

8-channel pipettes			
10 $\mu$ L	120 $\mu$ L	300 $\mu$ L	1200 $\mu$ L
<b>1 000</b>	✓	✓	✓



**8-CHANNEL PIPETTE  
RESERVOIR DOMINO**  
PN: 186009613

**FOR TUBES AND VIALS**

Ordering product number

**186010171**

OneLab reference: [218.3331]

## 24-WELL PHOTOREDOX BLOCK DOMINO

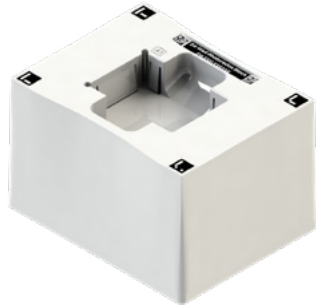

The 24-well Photoredox Block Domino is specifically designed to hold a single 24-well photoredox block assembly.

**SEE THIS DOMINO  
ON OUR E-SHOP**

# 24-well photoredox block assembly



**Manufacturer:**  
Analytical Sales &  
Services, Inc.

**Part number:**  
24253

1-channel pipettes					
10 $\mu$ L	120 $\mu$ L	300 $\mu$ L	1000 $\mu$ L	5mL	10mL
200	✓	✓	400	400	600

8-channel pipettes			
10 $\mu$ L	120 $\mu$ L	300 $\mu$ L	1200 $\mu$ L
✗	✗	✗	✗



24-WELL PHOTOREDOX  
BLOCK DOMINO  
PN: 186010171

Ordering product number

**186010096**

OneLab reference: [218.2331]

## 0.5-0.6ML MICROTUBE DOMINO



The 0.5-0.6mL Microtube Domino is designed to hold small-volume microtubes. It features a design that maintains attached caps of certain tubes in a vertical position to avoid automation collisions. It can hold up to 24 microtubes.

**SEE THIS DOMINO  
ON OUR E-SHOP**

# Eppendorf 0.5 mL DNA LoBind<sup>®</sup> microtube



**Manufacturer:**  
Eppendorf

**Part number:**  
0030108035

1-channel pipettes					
10 $\mu$ L	120 $\mu$ L	300 $\mu$ L	1000 $\mu$ L	5mL	10mL
✓	✓	✓	100	100	200

8-channel pipettes			
10 $\mu$ L	120 $\mu$ L	300 $\mu$ L	1200 $\mu$ L
✗	✗	✗	✗



0.5-0.6ML MICROTUBE  
DOMINO  
PN: 186010096



# Eppendorf 0.5 mL protein LoBind® microtube



**Manufacturer:**  
Eppendorf

**Part number:**  
0030108094

1-channel pipettes					
10µL	120µL	300µL	1000µL	5mL	10mL
40	✓	✓	120	🧪	🧪

8-channel pipettes			
10µL	120µL	300µL	1200µL
✗	✗	✗	✗



0.5-0.6ML MICROTUBE  
DOMINO  
PN: 186010096

# Eppendorf 0.5 mL Safe-Lock tube



**Manufacturer:**  
Eppendorf

**Part number:**  
0030121023

1-channel pipettes					
10 $\mu$ L	120 $\mu$ L	300 $\mu$ L	1000 $\mu$ L	5mL	10mL
40	✓	✓	120	🧪	🧪

8-channel pipettes			
10 $\mu$ L	120 $\mu$ L	300 $\mu$ L	1200 $\mu$ L
✗	✗	✗	✗



**0.5-0.6ML MICROTUBE**  
**DOMINO**  
PN: 186010096

# Qubit™ 0.5 mL assay tube



**Manufacturer:**  
Thermo Scientific

**Part number:**  
Q32856

1-channel pipettes					
10µL	120µL	300µL	1000µL	5mL	10mL
30	✓	✓	200	150	300

8-channel pipettes			
10µL	120µL	300µL	1200µL
✗	✗	✗	✗



0.5-0.6ML MICROTUBE  
DOMINO  
PN: 186010096

Ordering product number

**186009601**

OneLab reference: [218.2152]

## MICROTUBE DOMINO



The Microtube Domino is designed to hold a growing array of various microtube formats. It features a design that maintains attached caps of certain tubes in a vertical position to avoid automation colisions. It can hold up to 24 tubes.

[SEE THIS DOMINO  
ON OUR E-SHOP](#)

# 2 mL Conical Skirted Microtube with Screw Cap



**Manufacturer:**  
Sarstedt

**Part number:**  
72.694.006

1-channel pipettes					
10 $\mu$ L	120 $\mu$ L	300 $\mu$ L	1000 $\mu$ L	5mL	10mL
✓	✓	✓	✓	500	1 000

8-channel pipettes			
10 $\mu$ L	120 $\mu$ L	300 $\mu$ L	1200 $\mu$ L
✗	✗	✗	✗



**MICROTUBE DOMINO**  
PN: 186009601

# 2 mL Skirted Conical Base Screw Cap Microtube



MICROTUBE DOMINO  
PN: 186009601



**Manufacturer:**  
Sarstedt

**Part number:**  
72.694.396

1-channel pipettes					
10 $\mu$ L	120 $\mu$ L	300 $\mu$ L	1000 $\mu$ L	5mL	10mL
✓	✓	✓	✓	<b>700</b>	<b>1 100</b>

8-channel pipettes			
10 $\mu$ L	120 $\mu$ L	300 $\mu$ L	1200 $\mu$ L
✗	✗	✗	✗

# Axygen® 1.5 mL Maxymum Recovery® snaplock microtube



**Manufacturer:**  
Corning Inc.

**Part number:**  
MCT-150-L-C

1-channel pipettes					
10µL	120µL	300µL	1000µL	5mL	10mL
✓	✓	✓	✓	✓	<b>600</b>

8-channel pipettes			
10µL	120µL	300µL	1200µL
✗	✗	✗	✗



**MICROTUBE DOMINO**  
PN: 186009601

# Eppendorf 1.5 mL DNA LoBind<sup>®</sup> microtube



**Manufacturer:**  
Eppendorf

**Part number:**  
0030108051

1-channel pipettes					
10 $\mu$ L	120 $\mu$ L	300 $\mu$ L	1000 $\mu$ L	5mL	10mL
✓	✓	✓	✓	✓	<b>600</b>

8-channel pipettes			
10 $\mu$ L	120 $\mu$ L	300 $\mu$ L	1200 $\mu$ L
✗	✗	✗	✗



**MICROTUBE DOMINO**  
PN: 186009601



# Eppendorf 1.5 mL protein LoBind<sup>®</sup> microtube



**Manufacturer:**  
Eppendorf

**Part number:**  
0030108116

1-channel pipettes					
10 $\mu$ L	120 $\mu$ L	300 $\mu$ L	1000 $\mu$ L	5mL	10mL
✓	✓	✓	✓	✓	<b>600</b>

8-channel pipettes			
10 $\mu$ L	120 $\mu$ L	300 $\mu$ L	1200 $\mu$ L
✗	✗	✗	✗



**MICROTUBE DOMINO**  
PN: 186009601

# Eppendorf 1.5 mL Safe-Lock tube



**Manufacturer:**  
Eppendorf

**Part number:**  
0030120086

1-channel pipettes					
10 $\mu$ L	120 $\mu$ L	300 $\mu$ L	1000 $\mu$ L	5mL	10mL
✓	✓	✓	✓	✓	⚠

8-channel pipettes			
10 $\mu$ L	120 $\mu$ L	300 $\mu$ L	1200 $\mu$ L
✗	✗	✗	✗



**MICROTUBE DOMINO**  
PN: 186009601

# Eppendorf 2 mL DNA LoBind<sup>®</sup> microtube



**Manufacturer:**  
Eppendorf

**Part number:**  
0030108078

1-channel pipettes					
10 $\mu$ L	120 $\mu$ L	300 $\mu$ L	1000 $\mu$ L	5mL	10mL
✓	✓	✓	✓	✓	<b>600</b>

8-channel pipettes			
10 $\mu$ L	120 $\mu$ L	300 $\mu$ L	1200 $\mu$ L
✗	✗	✗	✗



**MICROTUBE DOMINO**  
PN: 186009601

# Eppendorf 2 mL protein LoBind<sup>®</sup> microtube



**Manufacturer:**  
Eppendorf

**Part number:**  
0030108132

1-channel pipettes					
10 $\mu$ L	120 $\mu$ L	300 $\mu$ L	1000 $\mu$ L	5mL	10mL
✓	✓	✓	✓	✓	<b>600</b>

8-channel pipettes			
10 $\mu$ L	120 $\mu$ L	300 $\mu$ L	1200 $\mu$ L
✗	✗	✗	✗



**MICROTUBE DOMINO**  
PN: 186009601

# Eppendorf 2 mL Safe-Lock tube



**Manufacturer:**  
Eppendorf

**Part number:**  
0030120094

1-channel pipettes					
10 $\mu$ L	120 $\mu$ L	300 $\mu$ L	1000 $\mu$ L	5mL	10mL
✓	✓	✓	✓	✓	<b>600</b>

8-channel pipettes			
10 $\mu$ L	120 $\mu$ L	300 $\mu$ L	1200 $\mu$ L
✗	✗	✗	✗



**MICROTUBE DOMINO**  
PN: 186009601

# Fisherbrand™ 0.5 mL free-standing microtube



**Manufacturer:**  
Fisher Scientific

**Part number:**  
02-682-559

1-channel pipettes					
10µL	120µL	300µL	1000µL	5mL	10mL
✓	✓	✓	✓	200	200

8-channel pipettes			
10µL	120µL	300µL	1200µL
✗	✗	✗	✗



**MICROTUBE DOMINO**  
PN: 186009601

# Fisherbrand™ 2 mL skirted conical microtube



**Manufacturer:**  
Fisher Scientific

**Part number:**  
12330433

1-channel pipettes					
10µL	120µL	300µL	1000µL	5mL	10mL
✓	✓	✓	✓	1 000	1 000

8-channel pipettes			
10µL	120µL	300µL	1200µL
✗	✗	✗	✗



**MICROTUBE DOMINO**  
PN: 186009601

# Fisherbrand™ Premium 1.5 mL microtube



**Manufacturer:**  
Fisher Scientific

**Part number:**  
11926955

1-channel pipettes					
10µL	120µL	300µL	1000µL	5mL	10mL
✓	✓	✓	✓	✓	⚠

8-channel pipettes			
10µL	120µL	300µL	1200µL
✗	✗	✗	✗



**MICROTUBE DOMINO**  
PN: 186009601



# Sarstedt, 0.5 mL skirted microtube with knurls



**Manufacturer:**  
Sarstedt

**Part number:**  
72.730.711

1-channel pipettes					
10 $\mu$ L	120 $\mu$ L	300 $\mu$ L	1000 $\mu$ L	5mL	10mL
✓	✓	✓	✓	✓	✓

8-channel pipettes			
10 $\mu$ L	120 $\mu$ L	300 $\mu$ L	1200 $\mu$ L
✗	✗	✗	✗



**MICROTUBE DOMINO**  
PN: 186009601

# Sarstedt, 1.5 mL conical microtube



**Manufacturer:**  
Sarstedt

**Part number:**  
72.690.001

1-channel pipettes					
10 $\mu$ L	120 $\mu$ L	300 $\mu$ L	1000 $\mu$ L	5mL	10mL
✓	✓	✓	✓	✓	⚠

8-channel pipettes			
10 $\mu$ L	120 $\mu$ L	300 $\mu$ L	1200 $\mu$ L
✗	✗	✗	✗



**MICROTUBE DOMINO**  
PN: 186009601

# Sarstedt, 2 mL screw-cap microtube



**Manufacturer:**  
Sarstedt

**Part number:**  
72.664

1-channel pipettes					
10 $\mu$ L	120 $\mu$ L	300 $\mu$ L	1000 $\mu$ L	5mL	10mL
✓	✓	✓	✓	1 000	1 000

8-channel pipettes			
10 $\mu$ L	120 $\mu$ L	300 $\mu$ L	1200 $\mu$ L
✗	✗	✗	✗



**MICROTUBE DOMINO**  
PN: 186009601

# Sarstedt 2 mL Polypropylene Reaction Tube



**Manufacturer:**  
Sarstedt

**Part number:**  
72.691

1-channel pipettes					
10 $\mu$ L	120 $\mu$ L	300 $\mu$ L	1000 $\mu$ L	5mL	10mL
✓	✓	✓	✓	✓	<b>300</b>

8-channel pipettes			
10 $\mu$ L	120 $\mu$ L	300 $\mu$ L	1200 $\mu$ L
✗	✗	✗	✗



**MICROTUBE DOMINO**  
PN: 186009601

# STARLAB, TubeOne<sup>®</sup> 2 mL microtube



**Manufacturer:**  
STARLAB

**Part number:**  
S1620-2700

1-channel pipettes					
10 $\mu$ L	120 $\mu$ L	300 $\mu$ L	1000 $\mu$ L	5mL	10mL
✓	✓	✓	✓	✓	<b>500</b>

8-channel pipettes			
10 $\mu$ L	120 $\mu$ L	300 $\mu$ L	1200 $\mu$ L
✗	✗	✗	✗



**MICROTUBE DOMINO**  
PN: 186009601

Ordering product number

**186010202**

OneLab reference: [218.4031]

## 5ML MICROTUBE DOMINO



The 5mL Microtube Domino is designed to hold a growing variety of mid-volume microtubes in various formats. It features a design that maintains attached caps of certain tubes in a vertical position to avoid automation collisions. It can hold up to 15 tubes.

**SEE THIS DOMINO  
ON OUR E-SHOP**

# Eppendorf 5 mL DNA LoBind<sup>®</sup> microtube



**Manufacturer:**  
Eppendorf

**Part number:**  
0030108310

1-channel pipettes					
10 $\mu$ L	120 $\mu$ L	300 $\mu$ L	1000 $\mu$ L	5mL	10mL
✓	✓	✓	✓	✓	✓

  

8-channel pipettes			
10 $\mu$ L	120 $\mu$ L	300 $\mu$ L	1200 $\mu$ L
✗	✗	✗	✗



**5ML MICROTUBE**  
**DOMINO**  
PN: 186010202

# Eppendorf 5 mL protein LoBind<sup>®</sup> microtube

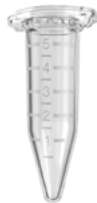

**Manufacturer:**  
Eppendorf

**Part number:**  
0030108302

1-channel pipettes					
10 $\mu$ L	120 $\mu$ L	300 $\mu$ L	1000 $\mu$ L	5mL	10mL
✓	✓	✓	✓	✓	✓

8-channel pipettes			
10 $\mu$ L	120 $\mu$ L	300 $\mu$ L	1200 $\mu$ L
✗	✗	✗	✗



**5ML MICROTUBE**  
**DOMINO**  
PN: 186010202



# Eppendorf 5 mL Tube® with screw cap



**Manufacturer:**  
Eppendorf

**Part number:**  
0030122305

1-channel pipettes					
10µL	120µL	300µL	1000µL	5mL	10mL
✓	✓	✓	✓	✓	✓

8-channel pipettes			
10µL	120µL	300µL	1200µL
✗	✗	✗	✗



**5ML MICROTUBE**  
**DOMINO**  
PN: 186010202

# Eppendorf 5 mL Tube<sup>®</sup> with snap cap



**Manufacturer:**  
Eppendorf

**Part number:**  
0030119401

1-channel pipettes					
10 $\mu$ L	120 $\mu$ L	300 $\mu$ L	1000 $\mu$ L	5mL	10mL
✓	✓	✓	✓	✓	✓

8-channel pipettes			
10 $\mu$ L	120 $\mu$ L	300 $\mu$ L	1200 $\mu$ L
✗	✗	✗	✗



**5ML MICROTUBE**  
**DOMINO**  
PN: 186010202

# VWR® 5 mL snap-cap centrifuge tube



**Manufacturer:**  
VWR International

**Part number:**  
10002-728

1-channel pipettes					
10µL	120µL	300µL	1000µL	5mL	10mL
✓	✓	✓	✓	✓	✓

8-channel pipettes			
10µL	120µL	300µL	1200µL
✗	✗	✗	✗



5ML MICROTUBE  
DOMINO  
PN: 186010202

Ordering product number

**186010089**

OneLab reference: [218.2242]

## 5ML ROUND BOTTOM TUBE DOMINO



The 5mL Round Bottom Tube Domino is designed to hold round-bottom tubes with working volumes of up to 5mL. It can hold up to 24 tubes.

**SEE THIS DOMINO  
ON OUR E-SHOP**

# Falcon® 5 mL round bottom test tube



**Manufacturer:**  
Corning Inc.

**Part number:**  
352008

1-channel pipettes					
10µL	120µL	300µL	1000µL	5mL	10mL
✓	✓	✓	1 000	2 000	

8-channel pipettes			
10µL	120µL	300µL	1200µL
✗	✗	✗	✗



5ML ROUND BOTTOM  
TUBE DOMINO  
PN: 186010089

# Fisherbrand™ 6 mL round-bottom glass tube with plain end



**Manufacturer:**  
Fisher Scientific

**Part number:**  
14-961-26

1-channel pipettes					
10µL	120µL	300µL	1000µL	5mL	10mL
✓	✓	✓	✓	✓	⚠

8-channel pipettes			
10µL	120µL	300µL	1200µL
✗	✗	✗	✗



5ML ROUND BOTTOM  
TUBE DOMINO  
PN: 186010089

# Fisherbrand™ 6 mL round-bottom glass tube with plain end



**Manufacturer:**  
Fisher Scientific

**Part number:**  
14-961-26

1-channel pipettes					
10µL	120µL	300µL	1000µL	5mL	10mL
✓	✓	✓	✓	✓	⚠

8-channel pipettes			
10µL	120µL	300µL	1200µL
✗	✗	✗	✗



5ML ROUND BOTTOM  
TUBE DOMINO  
PN: 186010089

# Sarstedt, 3.5 mL skirted V-bottom screw-cap tube



**Manufacturer:**  
Sarstedt

**Part number:**  
60.549.001

1-channel pipettes					
10 $\mu$ L	120 $\mu$ L	300 $\mu$ L	1000 $\mu$ L	5mL	10mL
✓	✓	✓	✓	2 000	2 500

8-channel pipettes			
10 $\mu$ L	120 $\mu$ L	300 $\mu$ L	1200 $\mu$ L
✗	✗	✗	✗



5ML ROUND BOTTOM  
TUBE DOMINO  
PN: 186010089



# VACUETTE® 2 mL virus stabilization tube



**Manufacturer:**  
Greiner Bio-One

**Part number:**  
456162

1-channel pipettes					
10µL	120µL	300µL	1000µL	5mL	10mL
<b>700</b>	✓	✓	✓	✓	<b>5 000</b>

8-channel pipettes			
10µL	120µL	300µL	1200µL
✗	✗	✗	✗



**5ML ROUND BOTTOM  
TUBE DOMINO**  
PN: 186010089

Ordering product number

**186010575**

OneLab reference: [218.5341]

## 5ML CRYOTUBE DOMINO



The 5mL Cryotube Domino is specifically designed to hold a growing array of cryotubes. It can hold up to 24 tubes.

**SEE THIS DOMINO  
ON OUR E-SHOP**

# 5 mL Cryotubes with External Thread



**Manufacturer:**  
Cromakit

**Part number:**  
BGN002

1-channel pipettes					
10 $\mu$ L	120 $\mu$ L	300 $\mu$ L	1000 $\mu$ L	5mL	10mL
✓	✓	✓	✓	✓	✓

8-channel pipettes			
10 $\mu$ L	120 $\mu$ L	300 $\mu$ L	1200 $\mu$ L
✗	✗	✗	✗



**5ML CRYOTUBE DOMINO**  
PN: 186010575

Ordering product number

**186010281**

OneLab reference: [218.4281]

## LABELED TEST TUBE DOMINO



The Labeled Test Tube Domino is specifically designed to hold a growing array of sample collection tubes. It's design leaves a small buffer zone around the tubes to avoid damaging their indispensable labels while not compromising on automation precision.

**SEE THIS DOMINO  
ON OUR E-SHOP**

# BD Vacutainer® 4 mL EDTA blood collection tube



LABELED TEST  
TUBE DOMINO  
PN: 186010281



**Manufacturer:**  
Becton Dickinson

**Part number:**  
367861

## 1-channel pipettes

10 $\mu$ L	120 $\mu$ L	300 $\mu$ L	1000 $\mu$ L	5mL	10mL
✓	✓	✓	✓	✓	<b>3 000</b>

## 8-channel pipettes

10 $\mu$ L	120 $\mu$ L	300 $\mu$ L	1200 $\mu$ L
✗	✗	✗	✗

# VACUETTE® 3 mL K2EDTA collection tube



**Manufacturer:**  
Greiner Bio-One

**Part number:**  
454246

1-channel pipettes					
10µL	120µL	300µL	1000µL	5mL	10mL
<b>500</b>	✓	✓	✓	✓	<b>3 500</b>

8-channel pipettes			
10µL	120µL	300µL	1200µL
✗	✗	✗	✗



LABELED TEST  
TUBE DOMINO  
PN: 186010281

# VACUETTE® 6 mL Trace Elements Sodium Heparin tube



**Manufacturer:**  
Greiner Bio-One

**Part number:**  
456275

1-channel pipettes					
10µL	120µL	300µL	1000µL	5mL	10mL
<b>600</b>	✓	✓	✓	✓	<b>5 000</b>

8-channel pipettes			
10µL	120µL	300µL	1200µL
✗	✗	✗	✗



LABELED TEST  
TUBE DOMINO  
PN: 186010281

# VACUETTE® 4 mL Z No Additive collection tube



**Manufacturer:**  
Greiner Bio-One

**Part number:**  
454001

1-channel pipettes					
10µL	120µL	300µL	1000µL	5mL	10mL
✓	✓	✓	✓	✓	<b>3 500</b>

8-channel pipettes			
10µL	120µL	300µL	1200µL
✗	✗	✗	✗



LABELED TEST  
TUBE DOMINO  
PN: 186010281



Ordering product number

**186010576**

OneLab reference: [218.5311]

## CONICAL BOTTOM TUBE DOMINO



The Conical Bottom Tube Domino is specifically designed to hold a growing variety of large-volume and non self-standing tubes that have a conical bottom. It can hold up to 2 tubes.

**SEE THIS DOMINO  
ON OUR E-SHOP**

# Corning® 250 mL centrifuge tube w/ plug seal cap



**Manufacturer:**  
Corning Inc.

**Part number:**  
430776

1-channel pipettes					
10µL	120µL	300µL	1000µL	5mL	10mL
70 000	12 000	10 000	✓	✓	✓

8-channel pipettes			
10µL	120µL	300µL	1200µL
✗	✗	✗	✗



CONICAL BOTTOM  
TUBE DOMINO  
PN: 186010576

Ordering product number

**186010163**

OneLab reference: [218.2931]

## 2ML CRYOGENIC STORAGE VIAL DOMINO



The 2mL Cryogenic Storage Vial Domino is designed to hold the most commonly used, 2mL cryogenic vials. It can hold up to 24 vials in individual positions.

**SEE THIS DOMINO  
ON OUR E-SHOP**

# Fisherbrand™ Cryogenic 2 mL external thread vial



**Manufacturer:**  
Fisher Scientific

**Part number:**  
10-500-26

1-channel pipettes					
10µL	120µL	300µL	1000µL	5mL	10mL
✓	✓	✓	✓	✓	<b>500</b>

8-channel pipettes			
10µL	120µL	300µL	1200µL
✗	✗	✗	✗



**2ML CRYOGENIC  
STORAGE VIAL DOMINO**  
PN: 186010163

Ordering product number

**186010173**

OneLab reference: [218.3391]

## 13ML TUBE DOMINO



The 13mL Tube Domino is designed to hold a growing array of tubes with the specific volume capacity of 13mL but in various formats. It can hold up to 24 Tubes.

**SEE THIS DOMINO  
ON OUR E-SHOP**

# 16x100mm collection tube, COPAN UTM<sup>®</sup> medium



**Manufacturer:**  
COPAN Diagnostics,  
Inc

**Part number:**  
330C

1-channel pipettes					
10 $\mu$ L	120 $\mu$ L	300 $\mu$ L	1000 $\mu$ L	5mL	10mL
✓	✓	✓	✓	✓	✓

8-channel pipettes			
10 $\mu$ L	120 $\mu$ L	300 $\mu$ L	1200 $\mu$ L
✗	✗	✗	✗



**13ML TUBE DOMINO**  
PN: 186010173

# DigiTUBE 15 mL 17x100mm autosampler tube



**Manufacturer:**  
SCP SCIENCE

**Part number:**  
010-515-607

1-channel pipettes					
10 $\mu$ L	120 $\mu$ L	300 $\mu$ L	1000 $\mu$ L	5mL	10mL
300	✓	✓	✓	✓	✓

8-channel pipettes			
10 $\mu$ L	120 $\mu$ L	300 $\mu$ L	1200 $\mu$ L
✗	✗	✗	✗



**13ML TUBE DOMINO**  
PN: 186010173

# Sarstedt, 13 mL U-bottom screw-cap tube



**Manufacturer:**  
Sarstedt

**Part number:**  
60.540.052

1-channel pipettes					
10 $\mu$ L	120 $\mu$ L	300 $\mu$ L	1000 $\mu$ L	5mL	10mL
1 300	✓	✓	✓	✓	✓

8-channel pipettes			
10 $\mu$ L	120 $\mu$ L	300 $\mu$ L	1200 $\mu$ L
✗	✗	✗	✗



**13ML TUBE DOMINO**  
PN: 186010173



Ordering product number

**186010165**

OneLab reference: [218.3031]

## 14ML ROUND BOTTOM TEST TUBE DOMINO



The 14mL Round Bottom Test Tube Domino is designed to hold specific tubes bearing the same name. It can hold up to 24 tubes.

[SEE THIS DOMINO  
ON OUR E-SHOP](#)

# DURAN® Disposable Culture Tubes with Screw Cap



**Manufacturer:**  
DWK Life Sciences

**Part number:**  
391-0145

1-channel pipettes					
10µL	120µL	300µL	1000µL	5mL	10mL
<b>2 500</b>	✓	✓	✓	✓	<b>6 000</b>

8-channel pipettes			
10µL	120µL	300µL	1200µL
✗	✗	✗	✗



**14ML ROUND BOTTOM  
TEST TUBE DOMINO**  
PN: 186010165

# Falcon® 14 mL round bottom test tube



**Manufacturer:**  
Corning Inc.

**Part number:**  
352059

## 1-channel pipettes

10µL	120µL	300µL	1000µL	5mL	10mL
✓	✓	✓	✓	✓	✓

## 8-channel pipettes

10µL	120µL	300µL	1200µL
✗	✗	✗	✗



14ML ROUND BOTTOM  
TEST TUBE DOMINO  
PN: 186010165

Ordering product number

**186010087**

OneLab reference: [218.2062]

## 15ML CONICAL CENTRIFUGE TUBE DOMINO



The 15mL Conical Centrifuge Tube Domino is designed to hold a growing array of standard, non self-standing 15mL tubes. It can hold up to 24 tubes.

**SEE THIS DOMINO  
ON OUR E-SHOP**

# 15 ml Centrifuge Tube, Conical, Loose (Sterile)



**Manufacturer:**  
Starlab

**Part number:**  
E1415-0100

1-channel pipettes					
10 $\mu$ L	120 $\mu$ L	300 $\mu$ L	1000 $\mu$ L	5mL	10mL
3 500	1 000	1 000	✓	✓	✓

8-channel pipettes			
10 $\mu$ L	120 $\mu$ L	300 $\mu$ L	1200 $\mu$ L
✗	✗	✗	✗



15ML CONICAL  
CENTRIFUGE  
TUBE DOMINO  
PN: 186010087

# CELLSTAR® 15 mL conical screw-cap tube



**Manufacturer:**  
Greiner Bio-One

**Part number:**  
188261

1-channel pipettes					
10µL	120µL	300µL	1000µL	5mL	10mL
4 000	1 000	1 000	✓	✓	1 500

8-channel pipettes			
10µL	120µL	300µL	1200µL
✗	✗	✗	✗



15ML CONICAL  
CENTRIFUGE  
TUBE DOMINO  
PN: 186010087

# CELLSTAR® 15 mL conical screw-cap tube, bulk



**Manufacturer:**  
Greiner Bio-One

**Part number:**  
188271

1-channel pipettes					
10µL	120µL	300µL	1000µL	5mL	10mL
4 000	1 000	1 000	✓	✓	1 500

8-channel pipettes			
10µL	120µL	300µL	1200µL
✗	✗	✗	✗



15ML CONICAL  
CENTRIFUGE  
TUBE DOMINO  
PN: 186010087

# Conical 15mL PP Tube centrifuge tube



**Manufacturer:**  
VWR International

**Part number:**  
525-0604

1-channel pipettes					
10 $\mu$ L	120 $\mu$ L	300 $\mu$ L	1000 $\mu$ L	5mL	10mL
3 500	✓	✓	✓	✓	✓

8-channel pipettes			
10 $\mu$ L	120 $\mu$ L	300 $\mu$ L	1200 $\mu$ L
✗	✗	✗	✗



15ML CONICAL  
CENTRIFUGE  
TUBE DOMINO  
PN: 186010087



# Corning® 15 mL conical centrifuge tube



**Manufacturer:**  
Corning Inc.

**Part number:**  
430790

1-channel pipettes					
10µL	120µL	300µL	1000µL	5mL	10mL
4 000	1 000	1 000	✓	✓	1 500

8-channel pipettes			
10µL	120µL	300µL	1200µL
✗	✗	✗	✗



15ML CONICAL  
CENTRIFUGE  
TUBE DOMINO  
PN: 186010087

# Falcon® 15 mL conical centrifuge tube



**Manufacturer:**  
Corning Inc.

**Part number:**  
352096

1-channel pipettes					
10µL	120µL	300µL	1000µL	5mL	10mL
4 000	1 000	1 000	✓	✓	1 500

8-channel pipettes			
10µL	120µL	300µL	1200µL
✗	✗	✗	✗



15ML CONICAL  
CENTRIFUGE  
TUBE DOMINO  
PN: 186010087

Ordering product number

**186010190**

OneLab reference: [218.3601]

## 20ML C15 B GLASS VIAL DOMINO



This Domino is designed to hold bespoke 20 mL C15 B Glass Vials. It can hold up to 15 vials.

**SEE THIS DOMINO  
ON OUR E-SHOP**

# 20 mL C15 B glass vial



**Manufacturer:**  
OEM

**Part number:**  
N/A

1-channel pipettes					
10 $\mu$ L	120 $\mu$ L	300 $\mu$ L	1000 $\mu$ L	5mL	10mL
✓	✓	✓	✓	✓	<b>7 000</b>

8-channel pipettes			
10 $\mu$ L	120 $\mu$ L	300 $\mu$ L	1200 $\mu$ L
✗	✗	✗	✗



**20ML C15 B  
GLASS VIAL DOMINO**  
PN: 186010190

Ordering product number

**186010191**

OneLab reference: [218.3631]

## FLAVER 30ML GLASS VIAL DOMINO



The FLAVER 30mL Glass Vial Domino is designed to hold vials bearing the same name. It can hold up to 6 vials.

[SEE THIS DOMINO  
ON OUR E-SHOP](#)

# FLAVER, 30 mL glass vial



**Manufacturer:**  
FLAVER AG

**Part number:**  
32.0030.W

## 1-channel pipettes

10 $\mu$ L	120 $\mu$ L	300 $\mu$ L	1000 $\mu$ L	5mL	10mL
✓	✓	✓	✓	✓	✓

## 8-channel pipettes

10 $\mu$ L	120 $\mu$ L	300 $\mu$ L	1200 $\mu$ L
✗	✗	✗	✗



FLAVER 30ML  
GLASS VIAL DOMINO  
PN: 186010191

# Nalgene™ 30 mL narrow-mouth HDPE bottle



**Manufacturer:**  
Nalgene

**Part number:**  
2002-0001

1-channel pipettes					
10µL	120µL	300µL	1000µL	5mL	10mL
✓	✓	✓	✓	✓	✓

8-channel pipettes			
10µL	120µL	300µL	1200µL
✗	✗	✗	✗



FLAVER 30ML  
GLASS VIAL DOMINO  
PN: 186010191

Ordering product number

**186010192**

OneLab reference: [218.3661]

## FLAVER 60ML GLASS VIAL DOMINO



The FLAVER 60mL Glass Vial Domino is designed to hold vials bearing the same name. It can hold up to 6 vials.

[SEE THIS DOMINO  
ON OUR E-SHOP](#)



# FLAVER, 60 mL glass vial



**Manufacturer:**  
FLAVER AG

**Part number:**  
32.0060.W

1-channel pipettes					
10 $\mu$ L	120 $\mu$ L	300 $\mu$ L	1000 $\mu$ L	5mL	10mL
✓	✓	✓	✓	✓	✓

8-channel pipettes			
10 $\mu$ L	120 $\mu$ L	300 $\mu$ L	1200 $\mu$ L
✗	✗	✗	✗



FLAVER 60ML  
GLASS VIAL DOMINO  
PN: 186010192

Ordering product number

**186009614**

OneLab reference: [218.2032]

## 50ML CONICAL CENTRIFUGE TUBE DOMINO



The 50mL Conical Centrifuge Tube Domino is designed to hold a growing array of standard, non self-standing 50mL tubes. It can hold up to 8 tubes.

[SEE THIS DOMINO  
ON OUR E-SHOP](#)

# 25mL Eppendorf Conical Tubes



**Manufacturer:**  
Eppendorf

**Part number:**  
0030122437

1-channel pipettes					
10 $\mu$ L	120 $\mu$ L	300 $\mu$ L	1000 $\mu$ L	5mL	10mL
✓	✓	✓	✓	✓	✓

8-channel pipettes			
10 $\mu$ L	120 $\mu$ L	300 $\mu$ L	1200 $\mu$ L
✗	✗	✗	✗



**50mL CONICAL  
CENTRIFUGE  
TUBE DOMINO**  
PN: 186009614

# 50mL ROTILABO® Sterile Centrifuge Tube



**Manufacturer:**  
Roth

**Part number:**  
N463.1

1-channel pipettes					
10µL	120µL	300µL	1000µL	5mL	10mL
✓	✓	✓	✓	✓	✓

8-channel pipettes			
10µL	120µL	300µL	1200µL
✗	✗	✗	✗



50ML CONICAL  
CENTRIFUGE  
TUBE DOMINO  
PN: 186009614

# CELLSTAR® 50 mL conical screw-cap tube



**Manufacturer:**  
Greiner Bio-One

**Part number:**  
227261

1-channel pipettes					
10µL	120µL	300µL	1000µL	5mL	10mL
✓	✓	✓	✓	✓	✓

8-channel pipettes			
10µL	120µL	300µL	1200µL
✗	✗	✗	✗



50ML CONICAL  
CENTRIFUGE  
TUBE DOMINO  
PN: 186009614

# Corning® 50 mL conical centrifuge tube



**Manufacturer:**  
Corning Inc.

**Part number:**  
430290

1-channel pipettes					
10µL	120µL	300µL	1000µL	5mL	10mL
✓	✓	✓	✓	✓	✓

8-channel pipettes			
10µL	120µL	300µL	1200µL
✗	✗	✗	✗



50ML CONICAL  
CENTRIFUGE  
TUBE DOMINO  
PN: 186009614

# Falcon® 50 mL conical centrifuge tube



**Manufacturer:**  
Corning Inc.

**Part number:**  
352070

1-channel pipettes					
10µL	120µL	300µL	1000µL	5mL	10mL
✓	✓	✓	✓	✓	✓

8-channel pipettes			
10µL	120µL	300µL	1200µL
✗	✗	✗	✗



50ML CONICAL  
CENTRIFUGE  
TUBE DOMINO  
PN: 186009614

# Greiner, 50 mL conical bottom tube



**Manufacturer:**  
Greiner Bio-One

**Part number:**  
227201

1-channel pipettes					
10 $\mu$ L	120 $\mu$ L	300 $\mu$ L	1000 $\mu$ L	5mL	10mL
✓	✓	✓	✓	✓	✓

8-channel pipettes			
10 $\mu$ L	120 $\mu$ L	300 $\mu$ L	1200 $\mu$ L
✗	✗	✗	✗



50ML CONICAL  
CENTRIFUGE  
TUBE DOMINO  
PN: 186009614



# Nunc™ 50 mL conical centrifuge tube



**Manufacturer:**  
Thermo Scientific

**Part number:**  
339652

1-channel pipettes					
10µL	120µL	300µL	1000µL	5mL	10mL
✓	✓	✓	✓	✓	✓

8-channel pipettes			
10µL	120µL	300µL	1200µL
✗	✗	✗	✗



50ML CONICAL  
CENTRIFUGE  
TUBE DOMINO  
PN: 186009614

# Sarstedt 50 mL Conical Screw Cap Tube



**Manufacturer:**  
Sarstedt

**Part number:**  
62547254

1-channel pipettes					
10 $\mu$ L	120 $\mu$ L	300 $\mu$ L	1000 $\mu$ L	5mL	10mL
✓	✓	✓	✓	✓	✓

8-channel pipettes			
10 $\mu$ L	120 $\mu$ L	300 $\mu$ L	1200 $\mu$ L
✗	✗	✗	✗



50ML CONICAL  
CENTRIFUGE  
TUBE DOMINO  
PN: 186009614

# VWR® 50 mL conical centrifuge tube



**Manufacturer:**  
VWR International

**Part number:**  
525-0610

1-channel pipettes					
10µL	120µL	300µL	1000µL	5mL	10mL
✓	✓	✓	✓	✓	✓

8-channel pipettes			
10µL	120µL	300µL	1200µL
✗	✗	✗	✗



50ML CONICAL  
CENTRIFUGE  
TUBE DOMINO  
PN: 186009614

Ordering product number

**186010582**

OneLab reference: [218.5671]

## 50ML PREPTUBE DOMINO



The 50mL PrepTube Domino is specifically designed for tubes bearing the same name used with Distek's PrepEngine system. It can hold up to 3 tubes.

**SEE THIS DOMINO  
ON OUR E-SHOP**

# 50mL PrepTube for Sample Preparation, for Distek PrepEngine



**Manufacturer:**  
VWR International

**Part number:**  
N/A

1-channel pipettes					
10 $\mu$ L	120 $\mu$ L	300 $\mu$ L	1000 $\mu$ L	5mL	10mL
✓	✓	✓	✓	✓	✓

8-channel pipettes			
10 $\mu$ L	120 $\mu$ L	300 $\mu$ L	1200 $\mu$ L
✗	✗	✗	✗



50mL PREPTUBE  
DOMINO  
PN: 186010582

Ordering product number

**186010092**

OneLab reference: [218.3091]

## 4ML AUTOSAMPLER VIAL DOMINO



The 4mL Autosampler Vial Domino is designed to hold a growing array of vials. It can hold up to 24 vials.

**SEE THIS DOMINO  
ON OUR E-SHOP**

# Fisherbrand™ 1.8 mL threaded amber glass vial



**Manufacturer:**  
Fisher Scientific

**Part number:**  
03-339-23A

1-channel pipettes					
10µL	120µL	300µL	1000µL	5mL	10mL
✓	✓	✓	✓	1 800	2 800

8-channel pipettes			
10µL	120µL	300µL	1200µL
✗	✗	✗	✗



4ML AUTOSAMPLER  
VIAL DOMINO  
PN: 186010092

# Fisherbrand™ 4 mL screw-top autosampler vial



**Manufacturer:**  
Fisher Scientific

**Part number:**  
03-391-19

1-channel pipettes					
10µL	120µL	300µL	1000µL	5mL	10mL
✓	✓	✓	✓	2 000	3 500

8-channel pipettes			
10µL	120µL	300µL	1200µL
✗	✗	✗	✗



4ML AUTOSAMPLER  
VIAL DOMINO  
PN: 186010092



# Fisherbrand™ Glass Threaded 1dr (3.7mL) vial



**Manufacturer:**  
Fisher Scientific

**Part number:**  
03-338A

1-channel pipettes					
10µL	120µL	300µL	1000µL	5mL	10mL
✓	✓	✓	✓	1 700	2 800

8-channel pipettes			
10µL	120µL	300µL	1200µL
✗	✗	✗	✗



4ML AUTOSAMPLER  
VIAL DOMINO  
PN: 186010092

# Interchim, 4 mL 15x45 mm screw-top glass vial



**Manufacturer:**  
Interchim

**Part number:**  
181859

1-channel pipettes					
10 $\mu$ L	120 $\mu$ L	300 $\mu$ L	1000 $\mu$ L	5mL	10mL
✓	✓	✓	✓	1 500	2 750

8-channel pipettes			
10 $\mu$ L	120 $\mu$ L	300 $\mu$ L	1200 $\mu$ L
✗	✗	✗	✗



4ML AUTOSAMPLER  
VIAL DOMINO  
PN: 186010092

Ordering product number

**186010168**

OneLab reference: [218.3161]

## SCIEX UNIVERSAL VIAL DOMINO



The SCIEX Universal Vial Domino is designed to hold specific one-time use vials. It can hold up to 24 vials.

**SEE THIS DOMINO  
ON OUR E-SHOP**

# SCIEX Universal Vial



**Manufacturer:**  
SCIEX

**Part number:**  
A62251

1-channel pipettes					
10 $\mu$ L	120 $\mu$ L	300 $\mu$ L	1000 $\mu$ L	5mL	10mL
✓	✓	✓	<b>300</b>	<b>300</b>	<b>600</b>

8-channel pipettes			
10 $\mu$ L	120 $\mu$ L	300 $\mu$ L	1200 $\mu$ L
✗	✗	✗	✗



**SCIEX UNIVERSAL**  
**VIAL DOMINO**  
PN: 186010168

Ordering product number

**186010283**

OneLab reference: [218.4311]

## SCIEX 6X6 TRAY DOMINO

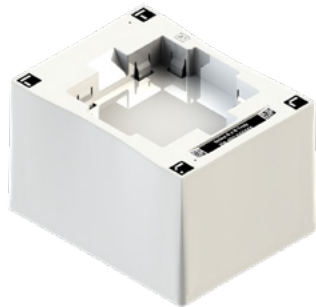

The SCIEX 6x6 Tray Domino is specifically designed to hold a dedicated 6x6 tray for Universal Vials.

**SEE THIS DOMINO  
ON OUR E-SHOP**

# SCIEX Universal Vial in 6x6 tray



**Manufacturer:**  
SCIEX

**Part number:**  
A62251

1-channel pipettes					
10 $\mu$ L	120 $\mu$ L	300 $\mu$ L	1000 $\mu$ L	5mL	10mL
✓	✓	✓	500	200	700

8-channel pipettes			
10 $\mu$ L	120 $\mu$ L	300 $\mu$ L	1200 $\mu$ L
✗	✗	✗	✗



SCIEX 6X6  
TRAY DOMINO  
PN: 186010283

Ordering product number

**186010198**

OneLab reference: [218.3941]

## 5ML SERUM VIAL DOMINO



The 5mL Serum Vial Domino is specifically designed to hold Serum vials with the specific volume capacity of up to 5mL. It can hold up to 15 vials.

**SEE THIS DOMINO  
ON OUR E-SHOP**

# WHEATON® 5 mL clear glass serum vial



**Manufacturer:**  
DWK Life Sciences

**Part number:**  
223685

1-channel pipettes					
10µL	120µL	300µL	1000µL	5mL	10mL
✓	✓	✓	✓	✓	✓

8-channel pipettes			
10µL	120µL	300µL	1200µL
✗	✗	✗	✗



5ML SERUM  
VIAL DOMINO  
PN: 186010198



Ordering product number

**186010164**

OneLab reference: [218.2961]

## 8ML SAMPLE VIAL DOMINO



The 8mL Sample Vial Domino is designed to hold vials with the specific volume capacity of 8mL. It can hold up to 24 vials.

**SEE THIS DOMINO  
ON OUR E-SHOP**

# Fisherbrand™ 8 mL Clear Screw Neck Vial



**Manufacturer:**  
Fisher Scientific

**Part number:**  
15091703

1-channel pipettes					
10µL	120µL	300µL	1000µL	5mL	10mL
✓	✓	✓	✓	3 500	5 000

8-channel pipettes			
10µL	120µL	300µL	1200µL
✗	✗	✗	✗



8ML SAMPLE  
VIAL DOMINO  
PN: 186010164

# SAR 16x93mm clear glass test tube



**Manufacturer:**

OEM

**Part number:**

N/A

## 1-channel pipettes

10 $\mu$ L	120 $\mu$ L	300 $\mu$ L	1000 $\mu$ L	5mL	10mL
✓	✓	✓	✓	✓	✓

## 8-channel pipettes

10 $\mu$ L	120 $\mu$ L	300 $\mu$ L	1200 $\mu$ L
✗	✗	✗	✗



8ML SAMPLE  
VIAL DOMINO  
PN: 186010164

# WHEATON® LAB FILE® 8 mL standard clear sample vial



**Manufacturer:**  
DWK Life Sciences

**Part number:**  
224804

1-channel pipettes					
10µL	120µL	300µL	1000µL	5mL	10mL
✓	✓	✓	✓	4 000	5 500

8-channel pipettes			
10µL	120µL	300µL	1200µL
✗	✗	✗	✗



8ML SAMPLE  
VIAL DOMINO  
PN: 186010164

Ordering product number

**186010199**

OneLab reference: [218.3911]

## 10ML SERUM VIAL DOMINO



The 10mL Serum Vial Domino is specifically designed to hold Serum vials with the specific volume capacity of up to 10mL. It can hold up to 15 vials.

**SEE THIS DOMINO  
ON OUR E-SHOP**

# WHEATON® 10 mL clear glass serum vial



**Manufacturer:**  
DWK Life Sciences

**Part number:**  
223686

1-channel pipettes					
10µL	120µL	300µL	1000µL	5mL	10mL
✓	✓	✓	✓	✓	✓

8-channel pipettes			
10µL	120µL	300µL	1200µL
✗	✗	✗	✗



**10ML SERUM  
VIAL DOMINO**  
PN: 186010199

Ordering product number

**186010201**

OneLab reference: [218.3881]

## 20ML SERUM VIAL DOMINO



The 20mL Serum Vial Domino is specifically designed to hold Serum vials with the specific volume capacity of up to 20mL. It can hold up to 8 vials.

**SEE THIS DOMINO  
ON OUR E-SHOP**

# WHEATON® 20 mL clear glass serum vial



**Manufacturer:**  
DWK Life Sciences

**Part number:**  
223687

1-channel pipettes					
10µL	120µL	300µL	1000µL	5mL	10mL
✓	✓	✓	✓	✓	✓

8-channel pipettes			
10µL	120µL	300µL	1200µL
✗	✗	✗	✗



20ML SERUM  
VIAL DOMINO  
PN: 186010201



Ordering product number

**186010097**

OneLab reference: [218.2361]

## 20ML REACTION VIAL DOMINO



The 20mL Reaction Vial Domino is designed to hold a growing array of mid-range volume vials. It can hold up to 12 vials.

**SEE THIS DOMINO  
ON OUR E-SHOP**

# Chemglass, 20 mL screw-top reaction vial



**Manufacturer:**  
Chemglass

**Part number:**  
CG-4912-05

1-channel pipettes					
10 $\mu$ L	120 $\mu$ L	300 $\mu$ L	1000 $\mu$ L	5mL	10mL
✓	✓	✓	✓	✓	✓

8-channel pipettes			
10 $\mu$ L	120 $\mu$ L	300 $\mu$ L	1200 $\mu$ L
✗	✗	✗	✗



20ML REACTION VIAL  
DOMINO  
PN: 186010097

# Fisherbrand™ 20mL Borosilicate Glass Scintillation Vial



**Manufacturer:**  
Fisher Scientific

**Part number:**  
03-337-5

1-channel pipettes					
10µL	120µL	300µL	1000µL	5mL	10mL
✓	✓	✓	✓	✓	✓

8-channel pipettes			
10µL	120µL	300µL	1200µL
✗	✗	✗	✗



20ML REACTION VIAL  
DOMINO  
PN: 186010097

# Fisherbrand™ Glass Threaded 6dr (22.2mL) vial



**Manufacturer:**  
Fisher Scientific

**Part number:**  
03-338G

1-channel pipettes					
10µL	120µL	300µL	1000µL	5mL	10mL
✓	✓	✓	✓	✓	✓

8-channel pipettes			
10µL	120µL	300µL	1200µL
✗	✗	✗	✗



20ML REACTION VIAL  
DOMINO  
PN: 186010097

# VWR® 20 mL EPA screw neck vial



**Manufacturer:**  
VWR International

**Part number:**  
VWRI548-0154A

1-channel pipettes					
10µL	120µL	300µL	1000µL	5mL	10mL
✓	✓	✓	✓	✓	✓

8-channel pipettes			
10µL	120µL	300µL	1200µL
✗	✗	✗	✗



20ML REACTION VIAL  
DOMINO  
PN: 186010097

Ordering product number

**186010166**

OneLab reference: [218.3061]

## 22ML GLASS VIAL DOMINO



The 22mL Glass Vial Domino is designed to hold specific glass vials with a total working volume of 22mL. It can hold up to 15 vials.

**SEE THIS DOMINO  
ON OUR E-SHOP**

# Supelco, 22 mL screw-top amber glass vial w/ Thermoset cap



**Manufacturer:**  
Merck

**Part number:**  
27004

## 1-channel pipettes

10 $\mu$ L	120 $\mu$ L	300 $\mu$ L	1000 $\mu$ L	5mL	10mL
✓	✓	✓	✓	✓	✓

## 8-channel pipettes

10 $\mu$ L	120 $\mu$ L	300 $\mu$ L	1200 $\mu$ L
✗	✗	✗	✗



22ML GLASS VIAL  
DOMINO  
PN: 186010166

# Thermo Scientific™ 22 mL screw-top sample vial



**Manufacturer:**  
Thermo Scientific

**Part number:**  
B7990-5

1-channel pipettes					
10 $\mu$ L	120 $\mu$ L	300 $\mu$ L	1000 $\mu$ L	5mL	10mL
✓	✓	✓	✓	✓	✓

8-channel pipettes			
10 $\mu$ L	120 $\mu$ L	300 $\mu$ L	1200 $\mu$ L
✗	✗	✗	✗



22ML GLASS VIAL  
DOMINO  
PN: 186010166



Ordering product number

**186010194**

OneLab reference: [218.3731]

## 29ML GLASS CULTURE TUBE DOMINO



The 29mL Glass Culture Tube Domino is designed to hold tall tubes with the specific volume capacity of up to 29mL. It can hold up to 24 tubes.

**SEE THIS DOMINO  
ON OUR E-SHOP**

# Globe Scientific, 29 mL 18x150mm glass culture tube



**Manufacturer:**  
Globe Scientific Inc.

**Part number:**  
1519

1-channel pipettes					
10 $\mu$ L	120 $\mu$ L	300 $\mu$ L	1000 $\mu$ L	5mL	10mL
<b>11 000</b>	<b>8 000</b>	<b>8 000</b>	<b>750</b>	<b>4 500</b>	<b>7 500</b>

8-channel pipettes			
10 $\mu$ L	120 $\mu$ L	300 $\mu$ L	1200 $\mu$ L
<b>×</b>	<b>×</b>	<b>×</b>	<b>×</b>



**29ML GLASS CULTURE  
TUBE DOMINO**  
PN: 186010194

Ordering product number

**186010307**

OneLab reference: [218.4871]

## Ø9MM GLASS VIAL DOMINO



The Ø9mm Glass Vial Domino is specifically designed to hold a growing array of glass vials with an exterior diameter of ~9mm. It can hold up to 48 vials.

**SEE THIS DOMINO  
ON OUR E-SHOP**

# Fisherbrand™ 1 mL short-style glass shell vial



**Manufacturer:**  
Fisher Scientific

**Part number:**  
03-339-30A

1-channel pipettes					
10µL	120µL	300µL	1000µL	5mL	10mL
✓	✓	✓	600	600	🧪

8-channel pipettes			
10µL	120µL	300µL	1200µL
✗	✗	✗	✗



Ø9MM GLASS  
VIAL DOMINO  
PN: 186010307

# KIMBLE® 1 mL clear glass shell vial



Ø9MM GLASS  
VIAL DOMINO  
PN: 186010307



**Manufacturer:**  
DWK Life Sciences

**Part number:**  
60831D-843

## 1-channel pipettes

10µL	120µL	300µL	1000µL	5mL	10mL
✓	✓	✓	900	🧪	🧪

## 8-channel pipettes

10µL	120µL	300µL	1200µL
✗	✗	✗	✗

Ordering product number

**186010280**

OneLab reference: [218.4221]

## Ø12MM VIAL DOMINO



The Ø12mm Vial Domino is specifically designed to hold a growing array of tubes with an exterior diameter of ~12mm. It can hold up to 24 vials.

**SEE THIS DOMINO  
ON OUR E-SHOP**

# Waters 300 $\mu$ L 12x32mm screw neck vial



SEE THIS CONSUMABLE  
ON OUR E-SHOP

**Manufacturer:**  
Waters Corporation

**Part number:**  
186002639

## 1-channel pipettes

10 $\mu$ L	120 $\mu$ L	300 $\mu$ L	1000 $\mu$ L	5mL	10mL
15	✓	✓	60	100	

## 8-channel pipettes

10 $\mu$ L	120 $\mu$ L	300 $\mu$ L	1200 $\mu$ L
✗	✗	✗	✗



Ø12MM VIAL DOMINO  
PN: 186010280

# Waters 700 $\mu$ L 12x32mm screw neck vial



SEE THIS CONSUMABLE  
ON OUR E-SHOP

**Manufacturer:**  
Waters Corporation

**Part number:**  
186005221

## 1-channel pipettes

10 $\mu$ L	120 $\mu$ L	300 $\mu$ L	1000 $\mu$ L	5mL	10mL
<b>100</b>	✓	✓	<b>300</b>	<b>300</b>	🧪

## 8-channel pipettes

10 $\mu$ L	120 $\mu$ L	300 $\mu$ L	1200 $\mu$ L
✗	✗	✗	✗



Ø12MM VIAL DOMINO  
PN: 186010280



# Waters QuanRecovery™ 300 µL 12x32mm screw neck vial



SEE THIS CONSUMABLE  
ON OUR E-SHOP

**Manufacturer:**  
Waters Corporation

**Part number:**  
186009186

1-channel pipettes					
10µL	120µL	300µL	1000µL	5mL	10mL
15	✓	✓	60	100	

8-channel pipettes			
10µL	120µL	300µL	1200µL
✗	✗	✗	✗



Ø12MM VIAL DOMINO  
PN: 186010280

Ordering product number

**186010312**

OneLab reference: [218.4901]

## Ø12.5MM TUBE AND VIAL DOMINO



The ø12.5mm Tube and Vial Domino is a Domino designed for versatile compatibility with both tubes and vials that have an exterior diameter of ~12.5mm. It can hold up to 48 individual labware.

**SEE THIS DOMINO  
ON OUR E-SHOP**

# ArcticWhite, 2 mL self-standing external thread cryovial with lip seal



**Manufacturer:**  
ArcticWhite LLC

**Part number:**  
CV3090102

1-channel pipettes					
10 $\mu$ L	120 $\mu$ L	300 $\mu$ L	1000 $\mu$ L	5mL	10mL
✓	✓	✓	✓	✓	<b>1 000</b>

8-channel pipettes			
10 $\mu$ L	120 $\mu$ L	300 $\mu$ L	1200 $\mu$ L
✗	✗	✗	✗



Ø12.5MM TUBE  
AND VIAL DOMINO  
PN: 186010312

# ArcticWhite, 3 mL self-standing external thread cryovial with lip seal



**Manufacturer:**  
ArcticWhite LLC

**Part number:**  
CV3090103

1-channel pipettes					
10 $\mu$ L	120 $\mu$ L	300 $\mu$ L	1000 $\mu$ L	5mL	10mL
✓	✓	✓	✓	1 300	2 300

8-channel pipettes			
10 $\mu$ L	120 $\mu$ L	300 $\mu$ L	1200 $\mu$ L
✗	✗	✗	✗



Ø12.5MM TUBE  
AND VIAL DOMINO  
PN: 186010312

Ordering product number

**186010257**

OneLab reference: [218.3971]

## Ø13MM TUBE DOMINO



The Ø13mm Tube Domino is specifically designed to hold a growing array of tubes with an exterior diameter of ~13mm. It can hold up to 24 tubes.

[SEE THIS DOMINO  
ON OUR E-SHOP](#)

# 13x84mm collection tube, virus preservation medium



**Manufacturer:**  
KANG JIAN Medical

**Part number:**  
KJ502-19C

1-channel pipettes					
10 $\mu$ L	120 $\mu$ L	300 $\mu$ L	1000 $\mu$ L	5mL	10mL
✓	✓	✓	✓	✓	<b>3 000</b>

8-channel pipettes			
10 $\mu$ L	120 $\mu$ L	300 $\mu$ L	1200 $\mu$ L
✗	✗	✗	✗



**Ø13MM TUBE DOMINO**  
PN: 186010257

# BD Vacutainer® 2 mL EDTA blood collection tube



**Manufacturer:**  
Becton Dickinson

**Part number:**  
367841

1-channel pipettes					
10µL	120µL	300µL	1000µL	5mL	10mL
✓	✓	✓	✓	✓	<b>3 500</b>

8-channel pipettes			
10µL	120µL	300µL	1200µL
✗	✗	✗	✗



**Ø13MM TUBE DOMINO**  
PN: 186010257

# Fisherbrand™ 10 mL round-bottom glass tube with plain end



**Manufacturer:**  
Fisher Scientific

**Part number:**  
14-961-27

1-channel pipettes					
10µL	120µL	300µL	1000µL	5mL	10mL
<b>500</b>	✓	✓	✓	✓	<b>5 500</b>

8-channel pipettes			
10µL	120µL	300µL	1200µL
✗	✗	✗	✗



Ø13MM TUBE DOMINO  
PN: 186010257



Ordering product number

**186010308**

OneLab reference: [218.4931]

## Ø16MM VIAL DOMINO



The Ø16mm Vial Domino is specifically designed to hold a growing array of vials with an exterior diameter of ~16mm. It can hold up to 24 vials. This Domino differs from Domino 186010298 not only by its smaller total vial capacity, but also because of the bottom format/shape of the vials it holds (flat-bottom vs. the round-bottom tubes held by Domino 186010298).

[SEE THIS DOMINO  
ON OUR E-SHOP](#)

# SCHOTT FIOLAX® 2 mL clear glass vial



**Manufacturer:**  
SCHOTT Pharma

**Part number:**  
1633341

1-channel pipettes					
10µL	120µL	300µL	1000µL	5mL	10mL
✓	✓	✓	3 000	2 500	🧪

8-channel pipettes			
10µL	120µL	300µL	1200µL
✗	✗	✗	✗



Ø16MM VIAL DOMINO  
PN: 186010308

Ordering product number

**186010159**

OneLab reference: [218.2781]

## 16X90MM GLASS TUBE DOMINO



The 16x90mm Glass Tube Domino is designed to hold a growing array of tall glass tubes with a 16mm diameter. It can hold up to 24 vials

[SEE THIS DOMINO  
ON OUR E-SHOP](#)

# 10 mL flat-bottom screw cap test tube



**Manufacturer:**  
Biosigma S.p.A

**Part number:**  
BSM440

1-channel pipettes					
10 $\mu$ L	120 $\mu$ L	300 $\mu$ L	1000 $\mu$ L	5mL	10mL
✓	✓	✓	✓	✓	✓

8-channel pipettes			
10 $\mu$ L	120 $\mu$ L	300 $\mu$ L	1200 $\mu$ L
✗	✗	✗	✗



**16X90MM**  
**GLASS TUBE DOMINO**  
PN: 186010159

# 16x100mm collection tube, IMPROVIRAL™ medium



**Manufacturer:**  
Improve Medical

**Part number:**  
8110111

## 1-channel pipettes

10µL	120µL	300µL	1000µL	5mL	10mL
✓	✓	✓	✓	✓	✓

## 8-channel pipettes

10µL	120µL	300µL	1200µL
✗	✗	✗	✗



**16X90MM**  
**GLASS TUBE DOMINO**  
PN: 186010159

# 16x100mm collection tube, virus preservation medium



**Manufacturer:**  
KANG JIAN Medical

**Part number:**  
KJ502-19A

## 1-channel pipettes

10 $\mu$ L	120 $\mu$ L	300 $\mu$ L	1000 $\mu$ L	5mL	10mL
✓	✓	✓	✓	✓	✓

## 8-channel pipettes

10 $\mu$ L	120 $\mu$ L	300 $\mu$ L	1200 $\mu$ L
✗	✗	✗	✗



**16X90MM**  
**GLASS TUBE DOMINO**  
PN: 186010159

# ACC, Pyrotube<sup>®</sup> 16x90mm depyrogenated glass tube



**Manufacturer:**

Associates of Cape  
Cod, Inc.

**Part number:**

TB16C

**1-channel pipettes**

10 $\mu$ L	120 $\mu$ L	300 $\mu$ L	1000 $\mu$ L	5mL	10mL
✓	✓	✓	✓	✓	✓

**8-channel pipettes**

10 $\mu$ L	120 $\mu$ L	300 $\mu$ L	1200 $\mu$ L
✗	✗	✗	✗



16X90MM

GLASS TUBE DOMINO

PN: 186010159

# Charles River, 16x90mm endotoxin-free glass tube



**Manufacturer:**  
Charles River

**Part number:**  
TL700

1-channel pipettes					
10 $\mu$ L	120 $\mu$ L	300 $\mu$ L	1000 $\mu$ L	5mL	10mL
✓	✓	✓	✓	✓	✗

8-channel pipettes			
10 $\mu$ L	120 $\mu$ L	300 $\mu$ L	1200 $\mu$ L
✗	✗	✗	✗



16X90MM  
GLASS TUBE DOMINO  
PN: 186010159



# Radleys, GreenHouse Plus reaction tube



**Manufacturer:**  
Radleys

**Part number:**  
RR99612

1-channel pipettes					
10 $\mu$ L	120 $\mu$ L	300 $\mu$ L	1000 $\mu$ L	5mL	10mL
<b>2 500</b>	✓	✓	✓	✓	<b>4 000</b>

8-channel pipettes			
10 $\mu$ L	120 $\mu$ L	300 $\mu$ L	1200 $\mu$ L
✗	✗	✗	✗



**16X90MM**  
**GLASS TUBE DOMINO**  
PN: 186010159

Ordering product number

**186010298**

OneLab reference: [218.4371]

## Ø16MM 30X TUBE DOMINO



The Ø16mm 30x Tube Domino is specifically designed to hold a growing array of tubes with an exterior diameter of ~16mm. It can hold up to 30 tubes. This Domino differs from Domino 186010308 not only by its larger total tube capacity, but also because of the bottom format/shape of the vials it holds (round-bottom tubes vs. the flat-bottom vials held by Domino 186010308).

**SEE THIS DOMINO  
ON OUR E-SHOP**

# BRAND® AR-GLAS® 13 mL 16x100mm culture tube



**Manufacturer:**  
BRAND

**Part number:**  
114115

1-channel pipettes					
10µL	120µL	300µL	1000µL	5mL	10mL
5 000	2 500	2 500	✓	✓	✓

8-channel pipettes			
10µL	120µL	300µL	1200µL
✗	✗	✗	✗



Ø16MM 30X  
TUBE DOMINO  
PN: 186010298

# DURAN® 17 mL 16x130mm test tube with straight rim



**Manufacturer:**  
DWK Life Sciences

**Part number:**  
261311608

1-channel pipettes					
10µL	120µL	300µL	1000µL	5mL	10mL
6 000	4 000	3 500	✓	✓	10 000

8-channel pipettes			
10µL	120µL	300µL	1200µL
✗	✗	✗	✗



Ø16MM 30X  
TUBE DOMINO  
PN: 186010298

# Globe Scientific, 14 mL 16x100mm glass culture tube



**Manufacturer:**  
Globe Scientific Inc.

**Part number:**  
1512

1-channel pipettes					
10 $\mu$ L	120 $\mu$ L	300 $\mu$ L	1000 $\mu$ L	5mL	10mL
5 500	2 000	2 000	✓	✓	✓

8-channel pipettes			
10 $\mu$ L	120 $\mu$ L	300 $\mu$ L	1200 $\mu$ L
✗	✗	✗	✗



Ø16MM 30X  
TUBE DOMINO  
PN: 186010298

# Globe Scientific, 19 mL 16x125mm glass culture tube



**Manufacturer:**  
Globe Scientific Inc.

**Part number:**  
1515

1-channel pipettes					
10 $\mu$ L	120 $\mu$ L	300 $\mu$ L	1000 $\mu$ L	5mL	10mL
4 000	1 500	1 500	✓	✓	4 000

8-channel pipettes			
10 $\mu$ L	120 $\mu$ L	300 $\mu$ L	1200 $\mu$ L
✗	✗	✗	✗



Ø16MM 30X  
TUBE DOMINO  
PN: 186010298

Ordering product number

**186010309**

OneLab reference: [218.5131]

## Ø19MM VIAL DOMINO



The Ø19mm Vial Domino is specifically designed to hold a growing array of vials with an exterior diameter of ~19mm. It can hold up to 48 vials.

**SEE THIS DOMINO  
ON OUR E-SHOP**

# CLS® 6 mL 19x40mm clear glass storage vial



**Manufacturer:**  
Zinsser Analytic GmbH

**Part number:**  
3088106

1-channel pipettes					
10µL	120µL	300µL	1000µL	5mL	10mL
✓	✓	✓	✓	✓	<b>2 000</b>

8-channel pipettes			
10µL	120µL	300µL	1200µL
✗	✗	✗	✗



**Ø19MM VIAL DOMINO**  
PN: 186010309



# WICOM 15mm Screw Vial, Brown Glass, 12mL



**Manufacturer:**  
Wicom

**Part number:**  
41515

1-channel pipettes					
10 $\mu$ L	120 $\mu$ L	300 $\mu$ L	1000 $\mu$ L	5mL	10mL
✓	✓	✓	✓	6 000	8 000

8-channel pipettes			
10 $\mu$ L	120 $\mu$ L	300 $\mu$ L	1200 $\mu$ L
✗	✗	✗	✗



Ø19MM VIAL DOMINO  
PN: 186010309

Ordering product number

**186010580**

OneLab reference: [218.5461]

## Ø21MM VIAL DOMINO



The ø21mm Vial Domino is specifically designed to hold vials with an exterior diameter of ~21mm. It can hold up to 15 vials.

**SEE THIS DOMINO  
ON OUR E-SHOP**

# Fisherbrand™ Glass Threaded 4dr (14.8mL) vial



**Manufacturer:**  
Fisher Scientific

**Part number:**  
03-338F

1-channel pipettes					
10µL	120µL	300µL	1000µL	5mL	10mL
✓	✓	✓	✓	✓	<b>4 000</b>

8-channel pipettes			
10µL	120µL	300µL	1200µL
✗	✗	✗	✗



**Ø21MM VIAL DOMINO**  
PN: 186010580

Ordering product number

**186010578**

OneLab reference: [218.5431]

## Ø23MM HEADSPACE VIAL DOMINO



The ø23mm Headspace Vial Domino is specifically designed to hold vials with an exterior diameter of ~23mm. It can hold up to 12 vials.

**SEE THIS DOMINO  
ON OUR E-SHOP**

# Agilent vial, screw top, headspace, clear, 20 mL, 23 x 75 mm



**Manufacturer:**  
Agilent Technologies

**Part number:**  
5188-2753

1-channel pipettes					
10 $\mu$ L	120 $\mu$ L	300 $\mu$ L	1000 $\mu$ L	5mL	10mL
✓	✓	✓	✓	✓	7 000

8-channel pipettes			
10 $\mu$ L	120 $\mu$ L	300 $\mu$ L	1200 $\mu$ L
✗	✗	✗	✗



Ø23MM HEADSPACE  
VIAL DOMINO  
PN: 186010578

Ordering product number

**186010581**

OneLab reference: [218.5641]

**Ø27MM VIAL DOMINO**



The ø27mm Vial Domino is specifically designed to hold vials with an exterior diameter of ~27mm. It can hold up to 12 vials.

**SEE THIS DOMINO  
ON OUR E-SHOP**

# 28mL (8 dram) Fisherbrand™ Glass vial



**Manufacturer:**  
Fisher Scientific

**Part number:**  
15364779

## 1-channel pipettes

10 $\mu$ L	120 $\mu$ L	300 $\mu$ L	1000 $\mu$ L	5mL	10mL
✓	✓	✓	✓	✓	✓

## 8-channel pipettes

10 $\mu$ L	120 $\mu$ L	300 $\mu$ L	1200 $\mu$ L
✗	✗	✗	✗



Ø27MM VIAL DOMINO  
PN: 186010581

Ordering product number

**186010299**

OneLab reference: [218.4401]

## Ø28MM TEST TUBE DOMINO



The Ø28mm Test Tube Domino is specifically designed to hold a growing array of test tubes with an exterior diameter of ~28mm. It can hold up to 8 tubes.

**SEE THIS DOMINO  
ON OUR E-SHOP**



# Lenz 28x150mm test tube with NS 24/29 socket



**Manufacturer:**  
Lenz Laborglas

**Part number:**  
5 7002 38

1-channel pipettes					
10 $\mu$ L	120 $\mu$ L	300 $\mu$ L	1000 $\mu$ L	5mL	10mL
15 000	5 000	5 000	✓	✓	✓

8-channel pipettes			
10 $\mu$ L	120 $\mu$ L	300 $\mu$ L	1200 $\mu$ L
✗	✗	✗	✗



Ø28MM TEST  
TUBE DOMINO  
PN: 186010299

Ordering product number

**186010572**

OneLab reference: [218.5161]

## TILTED VIAL DOMINO



The Tilted Vial Domino is specifically designed to hold vials in a slightly tilted position (10° angle) to minimize dead volume when automating their use. It can hold up to 12 vials.

**SEE THIS DOMINO  
ON OUR E-SHOP**

# 10 mL crimp-top glass vial



**Manufacturer:**  
Associates of Cape  
Cod, Inc.

**Part number:**  
N/A

1-channel pipettes					
10 $\mu$ L	120 $\mu$ L	300 $\mu$ L	1000 $\mu$ L	5mL	10mL
✓	✓	✓	✓	⚠	⚠

8-channel pipettes			
10 $\mu$ L	120 $\mu$ L	300 $\mu$ L	1200 $\mu$ L
✗	✗	✗	✗



**TILTED VIAL DOMINO**  
PN: 186010572

**FOR BOTTLES**

Ordering product number

**186010304**

OneLab reference: [218.4801]

## Ø46MM BOTTLE DOMINO



The Ø46mm Bottle Domino is specifically designed to hold a growing array of bottles with an exterior diameter of ~46mm. It can hold up to 3 bottles.

**SEE THIS DOMINO  
ON OUR E-SHOP**

# DURAN® 50 mL amber glass laboratory bottle



**Manufacturer:**  
DWK Life Sciences

**Part number:**  
218061758

1-channel pipettes					
10µL	120µL	300µL	1000µL	5mL	10mL
✓	✓	✓	✓	✓	✓

8-channel pipettes			
10µL	120µL	300µL	1200µL
✗	✗	✗	✗



Ø46MM  
BOTTLE DOMINO  
PN: 186010304

Ordering product number

**186010311**

OneLab reference: [218.5281]

## Ø51MM BOTTLE DOMINO



The ø51mm Bottle Domino is specifically designed to hold bottles with an exterior diameter of ~51mm. It can hold up to 4 bottles.

[SEE THIS DOMINO  
ON OUR E-SHOP](#)

# Qorpak™ 120 mL clear graduated medium round bottle



**Manufacturer:**

Qorpak

**Part number:**

GLC-01504

**1-channel pipettes**

10µL	120µL	300µL	1000µL	5mL	10mL
<b>3 000</b>	✓	✓	✓	✓	✓

**8-channel pipettes**

10µL	120µL	300µL	1200µL
✗	✗	✗	✗



Ø51MM BOTTLE DOMINO  
PN: 186010311



Ordering product number

**186010318**

OneLab reference: [218.4431]

## Ø55MM 10X BOTTLE DOMINO



The Ø55mm 10x Bottle Domino is specifically designed to hold up to 10 large-volume bottles. This Domino is a 1x2 format Domino. As of such, it takes 2 positions horizontally on the Andrew+ robot workbench.

[SEE THIS DOMINO  
ON OUR E-SHOP](#)

# DURAN® 100 mL clear glass laboratory bottle



**Manufacturer:**  
DWK Life Sciences

**Part number:**  
218012458

1-channel pipettes					
10µL	120µL	300µL	1000µL	5mL	10mL
✓	✓	✓	✓	✓	✓

8-channel pipettes			
10µL	120µL	300µL	1200µL
✗	✗	✗	✗



Ø55MM 10X  
BOTTLE DOMINO  
PN: 186010318

Ordering product number

**186010175**

OneLab reference: [218.3451]

## NALGENE™ 15ML BOTTLE DOMINO



The Nalgene™ 15mL Bottle Domino is specifically designed to hold bottles bearing the same name. It can hold up to 12 bottles.

[SEE THIS DOMINO  
ON OUR E-SHOP](#)

# 14mL (4 dram) Fisherbrand™ Glass vial



**Manufacturer:**  
Fisher Scientific

**Part number:**  
15354779

1-channel pipettes					
10µL	120µL	300µL	1000µL	5mL	10mL
✓	✓	✓	✓	✓	✓

8-channel pipettes			
10µL	120µL	300µL	1200µL
✗	✗	✗	✗



**NALGENEX™ 15ML  
BOTTLE DOMINO**  
PN: 186010175

# Nalgene™ 15 mL HDPE diagnostic bottle



**Manufacturer:**  
Nalgene

**Part number:**  
342002-9050

1-channel pipettes					
10µL	120µL	300µL	1000µL	5mL	10mL
✓	✓	✓	✓	✓	✓

8-channel pipettes			
10µL	120µL	300µL	1200µL
✗	✗	✗	✗



**NALGENE™ 15ML  
BOTTLE DOMINO**  
PN: 186010175

Ordering product number

**186010176**

OneLab reference: [218.3481]

## NALGENE™ 60ML BOTTLE DOMINO



The Nalgene™ 60mL Bottle Domino is specifically designed to hold bottles bearing the same name. It can hold up to 6 bottles.

**SEE THIS DOMINO  
ON OUR E-SHOP**

# Nalgene™ 60 mL narrow-mouth HDPE bottle



**Manufacturer:**  
Nalgene

**Part number:**  
342089-0002

1-channel pipettes					
10µL	120µL	300µL	1000µL	5mL	10mL
✓	✓	✓	✓	✓	✓

8-channel pipettes			
10µL	120µL	300µL	1200µL
✗	✗	✗	✗



**NALGENE™ 60ML  
BOTTLE DOMINO**  
PN: 186010176

Ordering product number

**186010162**

OneLab reference: [218.2871]

## 100ML BOTTLE MAGNETIC STIRRER DOMINO



The 100mL Bottle Stirrer Domino was developed for use with the V&P Scientific Multi Stirrus™ system, a rotary magnetic tumble stirrer (V&P Scientific, Inc, p/n VP 710D3 - not provided, to be purchased separately). The Multi Stirrus™ is not connected to OneLab and is therefore manually controlled by the user. It can hold and stir 2 bottles simultaneously in a single Domino position.

[SEE THIS DOMINO  
ON OUR E-SHOP](#)



# DURAN® 100 mL clear glass laboratory bottle



**Manufacturer:**  
DWK Life Sciences

**Part number:**  
218012458

1-channel pipettes					
10µL	120µL	300µL	1000µL	5mL	10mL
✓	✓	✓	✓	✓	✓

8-channel pipettes			
10µL	120µL	300µL	1200µL
✗	✗	✗	✗



100ML BOTTLE  
MAGNETIC STIRRER  
DOMINO  
PN: 186010162

Ordering product number

**186010177**

OneLab reference: [218.3511]

## NALGENE™ 125ML BOTTLE DOMINO



The Nalgene™ 125mL Bottle Domino is specifically designed to hold bottles bearing the same name. It can hold up to 4 bottles.

[SEE THIS DOMINO  
ON OUR E-SHOP](#)

# Nalgene™ 125 mL narrow-mouth HDPE bottle



**Manufacturer:**  
Nalgene

**Part number:**  
342089-0004

## 1-channel pipettes

10µL	120µL	300µL	1000µL	5mL	10mL
✓	✓	✓	✓	✓	✓

## 8-channel pipettes

10µL	120µL	300µL	1200µL
✗	✗	✗	✗



**NALGENE™ 125ML  
BOTTLE DOMINO**  
PN: 186010177

Ordering product number

**186010300**

OneLab reference: [218.5551]

## 125ML STORAGE BOTTLE DOMINO



The 125mL Storage Bottle Domino is designed to hold 2 round bottles in a single Domino position.

**SEE THIS DOMINO  
ON OUR E-SHOP**

# Costar® 125 mL Traditional Style Polystyrene Storage Bottle



**Manufacturer:**  
Corning Inc.

**Part number:**  
8388

1-channel pipettes					
10 $\mu$ L	120 $\mu$ L	300 $\mu$ L	1000 $\mu$ L	5mL	10mL
✓	✓	✓	✓	✓	✓

8-channel pipettes			
10 $\mu$ L	120 $\mu$ L	300 $\mu$ L	1200 $\mu$ L
✗	✗	✗	✗



**125ML STORAGE  
BOTTLE DOMINO**  
PN: 186010300

Ordering product number

**186010301**

OneLab reference: [218.5581]

## 125ML SQUARE BOTTLE DOMINO

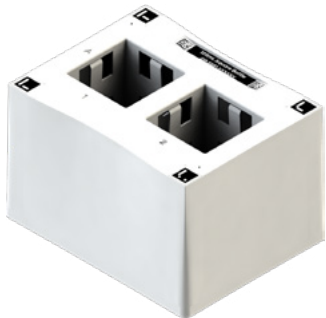

The 125mL Square Bottle Domino is designed to hold 2 square bottles in a single Domino position.

**SEE THIS DOMINO  
ON OUR E-SHOP**

# Nalgene 125mL bottle



**Manufacturer:**  
Thermo Scientific

**Part number:**  
0339072

1-channel pipettes					
10 $\mu$ L	120 $\mu$ L	300 $\mu$ L	1000 $\mu$ L	5mL	10mL
✓	✓	✓	✓	✓	✓

8-channel pipettes			
10 $\mu$ L	120 $\mu$ L	300 $\mu$ L	1200 $\mu$ L
✗	✗	✗	✗



125ML SQUARE BOTTLE  
DOMINO  
PN: 186010301

Ordering product number

**186010197**

OneLab reference: [218.3801]

## NALGENE™ 175ML BOTTLE DOMINO



The Nalgene™ 175mL Bottle Domino is specifically designed to hold bottles bearing the same name. It can hold up to 4 square bottles.

[SEE THIS DOMINO  
ON OUR E-SHOP](#)



# Nalgene™ 175 mL square wide-mouth HDPE bottle



**Manufacturer:**  
Nalgene

**Part number:**  
312114-0006

1-channel pipettes					
10µL	120µL	300µL	1000µL	5mL	10mL
✓	✓	✓	✓	✓	✓

8-channel pipettes			
10µL	120µL	300µL	1200µL
✗	✗	✗	✗



NALGENE™ 175ML  
BOTTLE DOMINO  
PN: 186010197

Ordering product number

**186010193**

OneLab reference: [218.3701]

## 250ML DURAN BOTTLE DOMINO



The 250mL Duran Bottle Domino is designed to hold 2, large-volume bottles in a single Domino position.

**SEE THIS DOMINO  
ON OUR E-SHOP**

# DURAN® 250 mL clear glass laboratory bottle



**Manufacturer:**  
DWK Life Sciences

**Part number:**  
218013651

1-channel pipettes					
10µL	120µL	300µL	1000µL	5mL	10mL
70 000	✓	✓	✓	✓	✓

8-channel pipettes			
10µL	120µL	300µL	1200µL
✗	✗	✗	✗



250ML DURAN  
BOTTLE DOMINO  
PN: 186010193

# Normax, 250 mL screw-cap laboratory bottle



**Manufacturer:**  
Normax

**Part number:**  
3.21801365

1-channel pipettes					
10 $\mu$ L	120 $\mu$ L	300 $\mu$ L	1000 $\mu$ L	5mL	10mL
70 000	✓	✓	✓	✓	✓

8-channel pipettes			
10 $\mu$ L	120 $\mu$ L	300 $\mu$ L	1200 $\mu$ L
✗	✗	✗	✗



**250ML DURAN  
BOTTLE DOMINO**  
PN: 186010193

Ordering product number

**186010090**

OneLab reference: [218.2751]

## 500ML ROUND BOTTLE DOMINO



The 500mL Round Bottle Domino is designed to hold a single, 500mL bottle. Ideal for workflows requiring large-volumes of reagent and/or buffers.

[SEE THIS DOMINO  
ON OUR E-SHOP](#)

# Corning® 500 mL easy-grip storage bottle



**Manufacturer:**  
Corning Inc.

**Part number:**  
430282

1-channel pipettes					
10µL	120µL	300µL	1000µL	5mL	10mL
150 000	✓	✓	✓	✓	✓

8-channel pipettes			
10µL	120µL	300µL	1200µL
✗	✗	✗	✗



500ML ROUND  
BOTTLE DOMINO  
PN: 186010090

# PYREX® 500 mL wide-mouth storage bottle



**Manufacturer:**  
Corning Inc.

**Part number:**  
1397-500

1-channel pipettes					
10 $\mu$ L	120 $\mu$ L	300 $\mu$ L	1000 $\mu$ L	5mL	10mL
✓	✓	✓	✓	✓	✓

8-channel pipettes			
10 $\mu$ L	120 $\mu$ L	300 $\mu$ L	1200 $\mu$ L
✗	✗	✗	✗



**500ML ROUND  
BOTTLE DOMINO**  
PN: 186010090

Ordering product number

**186010573**

OneLab reference: [218.5221]

## CONICAL BOTTOM 500ML TUBE DOMINO



The Conical Ø95mm Tube Domino is designed to hold a single, large-volume tube with a conical bottom in place on the Andrew+ workbench.

[SEE THIS DOMINO  
ON OUR E-SHOP](#)



# Corning® 500 mL conical centrifuge tube



**Manufacturer:**  
Corning Inc.

**Part number:**  
431123

## 1-channel pipettes

10µL	120µL	300µL	1000µL	5mL	10mL
50 000	10 000	10 000	✓	✓	✓

## 8-channel pipettes

10µL	120µL	300µL	1200µL
✗	✗	✗	✗



CONICAL BOTTOM  
500ML TUBE DOMINO  
PN: 186010573

**FOR OTHER  
CONSUMABLE TYPES**

Ordering product number

**186010579**

OneLab reference: [218.5521]

## SQUARE CUVETTE DOMINO



The Square Cuvette Domino is specifically designed to hold a growing variety of square cuvettes commonly used in UV spectrophotometry. It can hold up to 24 cuvettes.

[SEE THIS DOMINO  
ON OUR E-SHOP](#)

# 1.6 mL Semi-Micro Cuvette



**Manufacturer:**  
Greiner Bio-One

**Part number:**  
613101

1-channel pipettes					
10 $\mu$ L	120 $\mu$ L	300 $\mu$ L	1000 $\mu$ L	5mL	10mL
✓	✓	✓	600	700	900

8-channel pipettes			
10 $\mu$ L	120 $\mu$ L	300 $\mu$ L	1200 $\mu$ L
✗	✗	✗	✗



**SQUARE**  
**CUVETTE DOMINO**  
PN: 186010579

# 4 mL Macro Cuvette



**Manufacturer:**  
Greiner Bio-One

**Part number:**  
614101

1-channel pipettes					
10 $\mu$ L	120 $\mu$ L	300 $\mu$ L	1000 $\mu$ L	5mL	10mL
✓	✓	✓	✓	✓	<b>700</b>

8-channel pipettes			
10 $\mu$ L	120 $\mu$ L	300 $\mu$ L	1200 $\mu$ L
✗	✗	✗	✗



**SQUARE**  
**CUVETTE DOMINO**  
PN: 186010579

# BRAND™ UV-Cuvette Disposable Cuvet



**Manufacturer:**  
Fisher Scientific

**Part number:**  
759170

1-channel pipettes					
10µL	120µL	300µL	1000µL	5mL	10mL
✓	✓	✓	✓	✓	<b>1 300</b>

8-channel pipettes			
10µL	120µL	300µL	1200µL
✗	✗	✗	✗



**SQUARE  
CUVETTE DOMINO**  
PN: 186010579

# Labelians PMMA 4mL Cuvette



**Manufacturer:**  
Labelians

**Part number:**  
CU4UV-1

1-channel pipettes					
10 $\mu$ L	120 $\mu$ L	300 $\mu$ L	1000 $\mu$ L	5mL	10mL
✓	✓	✓	✓	✓	✓

8-channel pipettes			
10 $\mu$ L	120 $\mu$ L	300 $\mu$ L	1200 $\mu$ L
✗	✗	✗	✗



**SQUARE**  
**CUVETTE DOMINO**  
PN: 186010579

Ordering product number

**186010156**

OneLab reference: [218.2122]

## NUCLEOBOND XTRA MIDI COLUMN DOMINO



The NucleoBond Xtra Midi Column Domino is specifically designed to hold up to 3 columns bearing the same name. It is an indispensable component of the automated NucleoBond Xtra Midi Prep method on the Andrew+ Pipetting robot.

[SEE THIS DOMINO  
ON OUR E-SHOP](#)



# MACHEREY-NAGEL, NucleoBond Xtra Midi column



**Manufacturer:**  
MACHEREY-NAGEL

**Part number:**  
740410.10S



1-channel pipettes					
10µL	120µL	300µL	1000µL	5mL	10mL
✓	✓	✓	✓	✓	✓

8-channel pipettes			
10µL	120µL	300µL	1200µL
✗	✗	✗	✗



**NUCLEOBOND XTRA  
MIDI COLUMN DOMINO**  
PN: 186010156

**COOLED DOMINOS**

**FOR PLATES  
AND RESERVOIRS**

Ordering product number

**186010189**

OneLab reference: [218.2481]

## 96-PCR PLATE COOLED DOMINO

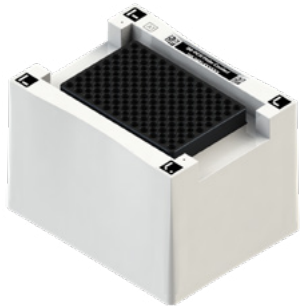

The 96-PCR Plate Cooled Domino is designed to hold specific 96-format plates for optimal cooling efficiency. The passive cooling technology of this Domino can keep the contents of plates cooled at  $\sim 4^{\circ}$  for about 5 hours.

**SEE THIS DOMINO  
ON OUR E-SHOP**

# Axygen® 96-well PCR white microplate



**Manufacturer:**  
Starlab

**Part number:**  
PCR-96-LC480-W-NF

1-channel pipettes					
10µL	120µL	300µL	1000µL	5mL	10mL
✓	✓	✓	✓	40	60

8-channel pipettes			
10µL	120µL	300µL	1200µL
✓	✓	✓	✓



96-PCR PLATE  
COOLED DOMINO  
PN: 186010189

# Thermo Scientific™ 96-well non-skirted PCR plate



**Manufacturer:**  
Thermo Scientific

**Part number:**  
AB0600

1-channel pipettes					
10 $\mu$ L	120 $\mu$ L	300 $\mu$ L	1000 $\mu$ L	5mL	10mL
✓	✓	✓	✓	✗	✗

8-channel pipettes			
10 $\mu$ L	120 $\mu$ L	300 $\mu$ L	1200 $\mu$ L
✓	✓	✓	✓



96-PCR PLATE  
COOLED DOMINO  
PN: 186010189

Ordering product number

**186010196**

OneLab reference: [218.3761]

## 384-PCR PLATE COOLED DOMINO

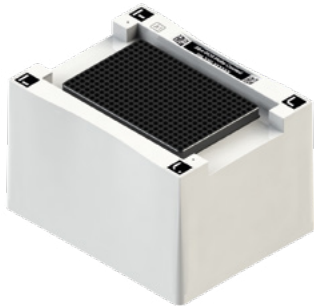

The 384-PCR Plate Cooled Domino is designed to hold specific 384-format plates for optimal cooling efficiency. The passive cooling technology of this Domino can keep the contents of plates cooled at  $\sim 4^{\circ}$  for about 5 hours.

**SEE THIS DOMINO  
ON OUR E-SHOP**

# Armadillo 384-well PCR plate, red



**Manufacturer:**  
Thermo Scientific

**Part number:**  
AB3384R

1-channel pipettes					
10 $\mu$ L	120 $\mu$ L	300 $\mu$ L	1000 $\mu$ L	5mL	10mL
✓	✓	✓	✓	✗	✗

8-channel pipettes			
10 $\mu$ L	120 $\mu$ L	300 $\mu$ L	1200 $\mu$ L
✓	✓	✓	<b>10</b>



**384-PCR PLATE**  
**COOLED DOMINO**  
PN: 186010196



# MicroAmp™ 40 µL optical 384-well skirted reaction plate w/ barcode



**Manufacturer:**  
Applied Biosystems

**Part number:**  
4309849

1-channel pipettes					
10µL	120µL	300µL	1000µL	5mL	10mL
✓	✓	✓	⚠	⚠	✗

8-channel pipettes			
10µL	120µL	300µL	1200µL
✓	✓	✓	⚠



384-PCR PLATE  
COOLED DOMINO  
PN: 186010196

Ordering product number

**186010169**

OneLab reference: [218.3191]

## 8-CHANNEL RESERVOIR COOLED DOMINO



The 8-Channel Reservoir Cooled Domino is designed to hold specific 8-channel reservoirs for optimal cooling efficiency. The passive cooling technology of this Domino can keep the contents of the reservoirs it holds at  $\sim 4^{\circ}$  for about 5 hours. It can hold up to 2, 10mL reservoirs.

**SEE THIS DOMINO  
ON OUR E-SHOP**

# INTEGRA 10 mL multichannel reservoir



**Manufacturer:**  
INTEGRA Biosciences

**Part number:**  
4332

1-channel pipettes					
10 $\mu$ L	120 $\mu$ L	300 $\mu$ L	1000 $\mu$ L	5mL	10mL
✓	✓	✓	✓	✓	✓

8-channel pipettes			
10 $\mu$ L	120 $\mu$ L	300 $\mu$ L	1200 $\mu$ L
<b>1 000</b>	✓	✓	✓



**8-CHANNEL RESERVOIR**  
**COOLED DOMINO**  
PN: 186010169

**FOR TUBES AND VIALS**

Ordering product number

**186010315**

OneLab reference: [218.4501]

## 0.5ML MICROTUBE COOLED DOMINO



The 0.5mL Microtube Cooled Domino is designed to hold specific 0.5mL microtubes for optimal cooling efficiency. The passive cooling technology of this Domino can keep the contents of up to 15 microtubes cooled at  $\sim 4^{\circ}$  for about 5 hours.

[SEE THIS DOMINO  
ON OUR E-SHOP](#)

# Eppendorf 0.5 mL protein LoBind® microtube



**Manufacturer:**  
Eppendorf

**Part number:**  
0030108094

1-channel pipettes					
10µL	120µL	300µL	1000µL	5mL	10mL
40	✓	✓	40	🧪	🧪

8-channel pipettes			
10µL	120µL	300µL	1200µL
✗	✗	✗	✗



**0.5ML MICROTUBE**  
**COOLED DOMINO**  
PN: 186010315

Ordering product number

**186010188**

OneLab reference: [218.2451]

## 1.5ML MICROTUBE COOLED DOMINO



The 1.5mL Microtube Cooled Domino is designed to hold specific microtubes for optimal cooling efficiency. The passive cooling technology of this Domino can keep the contents of up to 15 microtubes cooled at  $\sim 4^{\circ}$  for about 5 hours.

**SEE THIS DOMINO  
ON OUR E-SHOP**

# Eppendorf 1.5 mL Safe-Lock tube



**Manufacturer:**  
Eppendorf

**Part number:**  
0030120086

1-channel pipettes					
10 $\mu$ L	120 $\mu$ L	300 $\mu$ L	1000 $\mu$ L	5mL	10mL
✓	✓	✓	✓	✓	⚠

8-channel pipettes			
10 $\mu$ L	120 $\mu$ L	300 $\mu$ L	1200 $\mu$ L
✗	✗	✗	✗



**1.5ML MICROTUBE**  
**COOLED DOMINO**  
PN: 186010188



# Fisherbrand™ Premium 1.5 mL microtube



**Manufacturer:**  
Fisher Scientific

**Part number:**  
11926955

1-channel pipettes					
10µL	120µL	300µL	1000µL	5mL	10mL
✓	✓	✓	✓	✓	⚠

8-channel pipettes			
10µL	120µL	300µL	1200µL
✗	✗	✗	✗



**1.5ML MICROTUBE  
COOLED DOMINO**  
PN: 186010188

# Sarstedt, 1.5 mL conical microtube



**Manufacturer:**  
Sarstedt

**Part number:**  
72.690.001

1-channel pipettes					
10 $\mu$ L	120 $\mu$ L	300 $\mu$ L	1000 $\mu$ L	5mL	10mL
✓	✓	✓	✓	✓	✗

8-channel pipettes			
10 $\mu$ L	120 $\mu$ L	300 $\mu$ L	1200 $\mu$ L
✗	✗	✗	✗



**1.5ML MICROTUBE**  
**COOLED DOMINO**  
PN: 186010188

Ordering product number

**186010314**

OneLab reference: [218.4471]

## 2ML MICROTUBE COOLED DOMINO



The 2mL Microtube Cooled Domino is designed to hold specific 2mL microtubes for optimal cooling efficiency. The passive cooling technology of this Domino can keep the contents of up to 15 microtubes cooled at  $\sim 4^{\circ}$  for about 5 hours.

**SEE THIS DOMINO  
ON OUR E-SHOP**

# Sarstedt, 2 mL screw-cap microtube



**Manufacturer:**  
Sarstedt

**Part number:**  
72.664

1-channel pipettes					
10 $\mu$ L	120 $\mu$ L	300 $\mu$ L	1000 $\mu$ L	5mL	10mL
✓	✓	✓	✓	1 000	1 000

8-channel pipettes			
10 $\mu$ L	120 $\mu$ L	300 $\mu$ L	1200 $\mu$ L
✗	✗	✗	✗



**2ML MICROTUBE**  
**COOLED DOMINO**  
PN: 186010314

Ordering product number

**186010187**

OneLab reference: [218.2421]

## 15ML TUBE COOLED DOMINO



The 15mL Tube Cooled Domino is designed to hold specific 15mL tubes for optimal cooling efficiency. The passive cooling technology of this Domino can keep the contents of up to 10 tubes cooled at  $\sim 4^{\circ}$  for about 5 hours.

**SEE THIS DOMINO  
ON OUR E-SHOP**

# Falcon® 15 mL conical centrifuge tube



**Manufacturer:**  
Corning Inc.

**Part number:**  
352096

1-channel pipettes					
10µL	120µL	300µL	1000µL	5mL	10mL
4 000	1 000	1 000	✓	✓	1 500

8-channel pipettes			
10µL	120µL	300µL	1200µL
✗	✗	✗	✗



15ML TUBE COOLED  
DOMINO  
PN: 186010187

Ordering product number

**186010158**

OneLab reference: [218.2541]

## 50ML TUBE COOLED DOMINO



The 50mL Tube Cooled Domino is designed to hold specific 50mL tubes for optimal cooling efficiency. The passive cooling technology of this Domino can keep the contents of up to 6 tubes cooled at  $\sim 4^{\circ}$  for about 5 hours.

**SEE THIS DOMINO  
ON OUR E-SHOP**

# Corning® 50 mL conical centrifuge tube



**Manufacturer:**  
Corning Inc.

**Part number:**  
430290

1-channel pipettes					
10 $\mu$ L	120 $\mu$ L	300 $\mu$ L	1000 $\mu$ L	5mL	10mL
✓	✓	✓	✓	✓	✓

8-channel pipettes			
10 $\mu$ L	120 $\mu$ L	300 $\mu$ L	1200 $\mu$ L
✗	✗	✗	✗



50ML TUBE  
COOLED DOMINO  
PN: 186010158



# Falcon® 50 mL conical centrifuge tube



**Manufacturer:**  
Corning Inc.

**Part number:**  
352070

1-channel pipettes					
10 $\mu$ L	120 $\mu$ L	300 $\mu$ L	1000 $\mu$ L	5mL	10mL
✓	✓	✓	✓	✓	✓

8-channel pipettes			
10 $\mu$ L	120 $\mu$ L	300 $\mu$ L	1200 $\mu$ L
✗	✗	✗	✗



**50ML TUBE**  
**COOLED DOMINO**  
PN: 186010158

# Nunc™ 50 mL conical centrifuge tube



**Manufacturer:**  
Thermo Scientific

**Part number:**  
339652

1-channel pipettes					
10µL	120µL	300µL	1000µL	5mL	10mL
✓	✓	✓	✓	✓	✓

8-channel pipettes			
10µL	120µL	300µL	1200µL
✗	✗	✗	✗



50ML TUBE  
COOLED DOMINO  
PN: 186010158

# VWR® 50 mL conical centrifuge tube



**Manufacturer:**  
VWR International

**Part number:**  
525-0610

1-channel pipettes					
10 $\mu$ L	120 $\mu$ L	300 $\mu$ L	1000 $\mu$ L	5mL	10mL
✓	✓	✓	✓	✓	✓

8-channel pipettes			
10 $\mu$ L	120 $\mu$ L	300 $\mu$ L	1200 $\mu$ L
✗	✗	✗	✗



50ML TUBE  
COOLED DOMINO  
PN: 186010158

**RACK DOMINOS**

**COLLECTION LABWARE  
RACK DOMINO**

Ordering product number

**186010523**

OneLab reference: [218.4611]

## COLLECTION LABWARE RACK DOMINO

### DIRECT COMPATIBILITY



The Collection Rack Domino is compatible with an expanding range of Collection Racks. It enables fully automated SPE workflows by allowing automated consumable movements to and from the Extraction+ manifold base by the Andrew+ robot equipped with the Microplate Gripper Tool.

**SEE THIS DOMINO  
ON OUR E-SHOP**

# ArcticWhite, 290 mL single cavity reservoir



**Manufacturer:**  
ArcticWhite LLC

**Part number:**  
AWLS-S30017



## 1-channel pipettes

10 $\mu$ L	120 $\mu$ L	300 $\mu$ L	1000 $\mu$ L	5mL	10mL
✓	✓	✓	✓	✓	✓

## 8-channel pipettes

10 $\mu$ L	120 $\mu$ L	300 $\mu$ L	1200 $\mu$ L
✓	✓	✓	✓



COLLECTION LABWARE  
RACK DOMINO  
Direct Compatibility  
186010523

# Axygen® 96 V-bottom single well reservoir



**Manufacturer:**  
Corning Inc.

**Part number:**  
RES-SW96-HP-SI



1-channel pipettes					
10µL	120µL	300µL	1000µL	5mL	10mL
✓	✓	✓	✓	✓	✓

8-channel pipettes			
10µL	120µL	300µL	1200µL
✓	✓	✓	✓



**COLLECTION LABWARE**  
**RACK DOMINO**  
Direct Compatibility  
186010523



Ordering product number  
**186010523**

OneLab reference: [218.4611]

# COLLECTION LABWARE RACK DOMINO

EQUIPPED WITH 0.2ML MICROTUBE RACK (requires 186010303)

24X

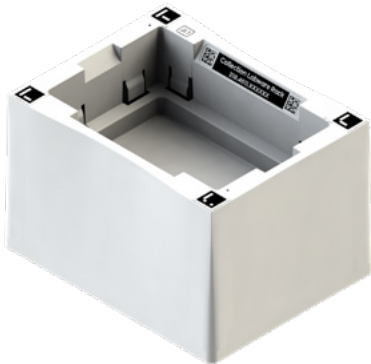

Ordering product number  
**186010534**

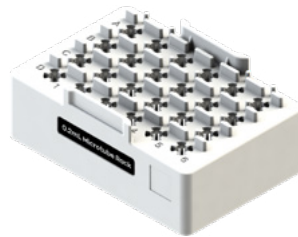

0.2mL Microtube Rack Domino

OneLab reference: [218.5071]



## IMPORTANT

Compatibility of the 0.2mL Microtube Rack with the Collection Labware Rack Domino requires the purchase of the 0.2mL Microtube Rack Domino bundle (186010303).

# Thermo Scientific™ 0.2 mL PCR microtube, racked



**Manufacturer:**  
Thermo Scientific

**Part number:**  
AB0620

1-channel pipettes					
10 $\mu$ L	120 $\mu$ L	300 $\mu$ L	1000 $\mu$ L	5mL	10mL
✓	✓	✓	50	⚠	⚠

8-channel pipettes			
10 $\mu$ L	120 $\mu$ L	300 $\mu$ L	1200 $\mu$ L
✗	✗	✗	✗

**COLLECTION LABWARE**  
**RACK DOMINO**  
Equipped with  
0.2mL Microtube Rack  
PN: 186010523  
+ 186010534



Ordering product number

**186010523**

OneLab reference: [218.4611]

# COLLECTION LABWARE RACK DOMINO

EQUIPPED WITH 4ML VIAL COLLECTION RACK

24X



Ordering product number

**186011193**



4mL Vial Collection Rack

OneLab reference: [519.2800]



# Clear Glass 4 mL Screw Neck Vial, racked



SEE THIS CONSUMABLE  
ON OUR E-SHOP

**Manufacturer:**  
Waters Corporation

**Part number:**  
186000840

1-channel pipettes					
10 $\mu$ L	120 $\mu$ L	300 $\mu$ L	1000 $\mu$ L	5mL	10mL
✓	✓	✓	✓	1 500	2 700

8-channel pipettes			
10 $\mu$ L	120 $\mu$ L	300 $\mu$ L	1200 $\mu$ L
✗	✗	✗	✗



+



**COLLECTION LABWARE**  
**RACK DOMINO**  
Equipped with  
4mL Vial Collection Rack  
PN: 186010523  
+ 186011193

Ordering product number

**186010523**

OneLab reference: [218.4611]

## COLLECTION LABWARE RACK DOMINO

EQUIPPED WITH THE 5ML TUBE COLLECTION RACK



Ordering product number

**186010534**

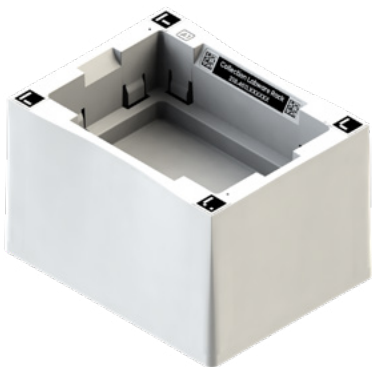

5mL Tube Collection Rack

OneLab reference: [519.2651]



### IMPORTANT

The 5mL Tube Collection Rack (12-position rack) is manufactured by Waters Corporation and specifically designed for use with the **Extraction+** connected device. The 5mL Tube Collection Rack is sold separately from the Collection Labware Rack Domino. It is only supplied with the Collection Labware Rack Domino in the case of the Extraction+ 6cc Cartridge Kit (176005206).

# VWR® 5 mL snap-cap centrifuge tube, racked



**Manufacturer:**  
VWR International

**Part number:**  
10002-728

1-channel pipettes					
10µL	120µL	300µL	1000µL	5mL	10mL
✓	✓	✓	✓	✓	✓

8-channel pipettes			
10µL	120µL	300µL	1200µL
✗	✗	✗	✗



**COLLECTION LABWARE**  
**RACK DOMINO**  
Compatibility via  
5mL Tube Collection Rack  
PN: 186010523  
+ 186010534

Ordering product number

**186010523**

OneLab reference: [218.4611]

# COLLECTION LABWARE RACK DOMINO

EQUIPPED WITH Ø12MM VIAL COLLECTION RACK

24X

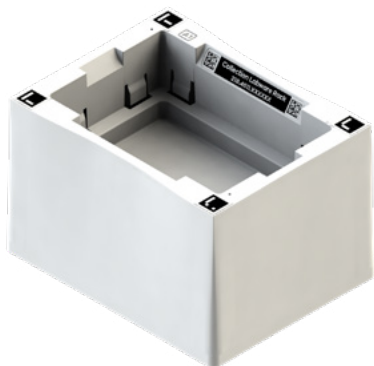

Ordering product number

**186010531**

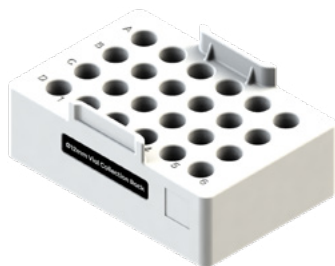

Ø12mm Vial Collection Rack

OneLab reference: [519.2601]



## IMPORTANT

The Ø12mm Vial Collection Rack (24-position rack) is manufactured by Waters Corporation and specifically designed for use with the **Extraction+** connected device. The Ø12mm Vial Collection Rack is sold separately from the Collection Labware Rack Domino. It is only supplied with the Collection Labware Rack Domino in the case of the Extraction+ 1cc and 3cc Cartridge Kits (176005204 & 176005205).

# Waters 2 mL 12x32 mm LC/GC screw-top vial, racked



SEE THIS CONSUMABLE  
ON OUR E-SHOP

**Manufacturer:**  
Waters Corporation

**Part number:**  
186000272C

1-channel pipettes					
10 $\mu$ L	120 $\mu$ L	300 $\mu$ L	1000 $\mu$ L	5mL	10mL
✓	✓	✓	1 000	🚫	🚫

8-channel pipettes			
10 $\mu$ L	120 $\mu$ L	300 $\mu$ L	1200 $\mu$ L
✗	✗	✗	✗

**COLLECTION LABWARE**  
**RACK DOMINO**  
Equipped with  
 $\varnothing$ 12mm Vial Collection Rack  
PN: 186010523  
+ 186010531





# Waters 300 $\mu$ L 12x32mm screw neck vial, racked



SEE THIS CONSUMABLE  
ON OUR E-SHOP

**Manufacturer:**  
Waters Corporation

**Part number:**  
186002639

1-channel pipettes					
10 $\mu$ L	120 $\mu$ L	300 $\mu$ L	1000 $\mu$ L	5mL	10mL
✓	✓	✓	150	🧪	🧪

8-channel pipettes			
10 $\mu$ L	120 $\mu$ L	300 $\mu$ L	1200 $\mu$ L
✗	✗	✗	✗

COLLECTION LABWARE  
RACK DOMINO  
Equipped with  
 $\varnothing$ 12mm Vial Collection Rack  
PN: 186010523  
+ 186010531



# Waters 700 $\mu$ L 12x32mm screw neck vial, racked



SEE THIS CONSUMABLE  
ON OUR E-SHOP

**Manufacturer:**  
Waters Corporation

**Part number:**  
186005221

1-channel pipettes					
10 $\mu$ L	120 $\mu$ L	300 $\mu$ L	1000 $\mu$ L	5mL	10mL
✓	✓	✓	500	🧪	🧪

8-channel pipettes			
10 $\mu$ L	120 $\mu$ L	300 $\mu$ L	1200 $\mu$ L
✗	✗	✗	✗

COLLECTION LABWARE  
RACK DOMINO  
Equipped with  
 $\varnothing$ 12mm Vial Collection Rack  
PN: 186010523  
+ 186010531



# Waters QuanRecovery™ 300 µL 12x32mm screw neck vial, racked



**Manufacturer:**  
Waters Corporation

**Part number:**  
186009186

SEE THIS CONSUMABLE  
ON OUR E-SHOP

1-channel pipettes					
10µL	120µL	300µL	1000µL	5mL	10mL
✓	✓	✓	150	⚠	⚠

8-channel pipettes			
10µL	120µL	300µL	1200µL
✗	✗	✗	✗

COLLECTION LABWARE  
RACK DOMINO  
Equipped with  
ø12mm Vial Collection Rack  
PN: 186010523  
+ 186010531



Ordering product number

**186010523**

OneLab reference: [218.4611]

# COLLECTION LABWARE RACK DOMINO

EQUIPPED WITH 10ML VIAL COLLECTION RACK

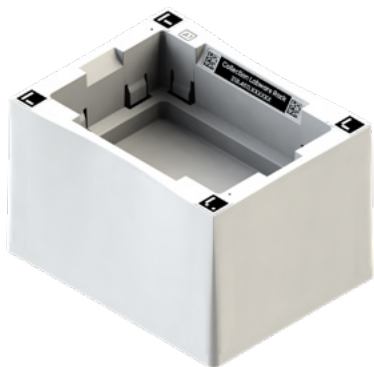

Ordering product number

**186111118**



10mL Vial Collection Rack

OneLab reference: [519.274]



## IMPORTANT

The 10mL Vial Collection Rack is manufactured by Waters and is specifically designed for use with the **Extraction+** Connected Device. The 10mL Vial Collection Rack is sold separately from the Collection Labware Rack Domino. It is only supplied with the Collection Labware Rack Domino in the case of the Extraction+ 6cc - 8 position cartridge kit 176005433)

# WHEATON® 10 mL clear glass serum vial, racked



**Manufacturer:**  
DWK Life Sciences

**Part number:**  
223686

1-channel pipettes					
10µL	120µL	300µL	1000µL	5mL	10mL
✓	✓	✓	✓	✓	✓

8-channel pipettes			
10µL	120µL	300µL	1200µL
✗	✗	✗	✗



**COLLECTION LABWARE**  
**RACK DOMINO**  
Equipped with  
10mL Vial Collection Rack  
PN: 186010523  
+ 186111118

Ordering product number

**186010523**

OneLab reference: [218.4611]

# COLLECTION LABWARE RACK DOMINO

EQUIPPED WITH CRYOVIAL COLLECTION RACK

24X

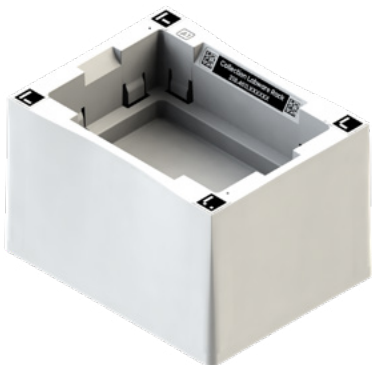

Ordering product number

**186011194**



Cryovial Collection Rack

OneLab reference: [518.3433]



# 2mL cryovial with Inner Thread, in 24 position rack



**Manufacturer:**

Biozym

**Part number:**

710522

1-channel pipettes					
10 $\mu$ L	120 $\mu$ L	300 $\mu$ L	1000 $\mu$ L	5mL	10mL
✓	✓	✓	✓	✓	✓

8-channel pipettes			
10 $\mu$ L	120 $\mu$ L	300 $\mu$ L	1200 $\mu$ L
✗	✗	✗	✗



**COLLECTION LABWARE**  
**RACK DOMINO**  
Equipped with  
Cryovial Collection Rack  
PN: 186010523  
+ 186011194

Ordering product number

**186010305**

OneLab reference: [218.4641]

## RACKED TUBES DOMINO

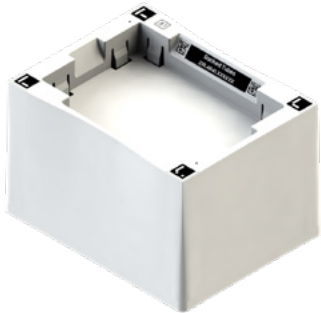

The Racked Tubes Domino is designed to hold various types of tubes that are positioned within existing storage racks. The Racked Tubes Domino holds these racks in place rather than the individual tubes themselves. As of such, the number of tubes supported can vary.

**SEE THIS DOMINO  
ON OUR E-SHOP**



# Micronic 1.1 mL 2D-coded internal thread V-bottom tube in 96x rack



**Manufacturer:**  
Micronic

**Part number:**  
MP52318L

1-channel pipettes					
10 $\mu$ L	120 $\mu$ L	300 $\mu$ L	1000 $\mu$ L	5mL	10mL
✓	✓	✓	500	🚫	🚫

8-channel pipettes			
10 $\mu$ L	120 $\mu$ L	300 $\mu$ L	1200 $\mu$ L
✓	✓	✓	200



**RACKED TUBES DOMINO**  
PN: 186010305

# Micronic 1.4 mL 2D-coded internal thread V-bottom tube in 96x rack



**Manufacturer:**  
Micronic

**Part number:**  
MP52353L

1-channel pipettes					
10 $\mu$ L	120 $\mu$ L	300 $\mu$ L	1000 $\mu$ L	5mL	10mL
✓	✓	✓	800	🚫	🚫

8-channel pipettes			
10 $\mu$ L	120 $\mu$ L	300 $\mu$ L	1200 $\mu$ L
✓	✓	✓	300



**RACKED TUBES DOMINO**  
PN: 186010305

# Micronic 1.4mL Round Bottom Tubes



**Manufacturer:**  
Micronic

**Part number:**  
MP32022

1-channel pipettes					
10 $\mu$ L	120 $\mu$ L	300 $\mu$ L	1000 $\mu$ L	5mL	10mL
✓	120	✓	600	600	800

8-channel pipettes			
10 $\mu$ L	120 $\mu$ L	300 $\mu$ L	1200 $\mu$ L
250	120	✓	✓



**RACKED TUBES DOMINO**  
PN: 186010305

# Micronic 3 mL 2D-coded external thread Flat-bottom tube in 48x rack



**Manufacturer:**  
Micronic

**Part number:**  
MP52861

1-channel pipettes					
10 $\mu$ L	120 $\mu$ L	300 $\mu$ L	1000 $\mu$ L	5mL	10mL
✓	✓	✓	✓	✓	<b>400</b>

8-channel pipettes			
10 $\mu$ L	120 $\mu$ L	300 $\mu$ L	1200 $\mu$ L
✗	✗	✗	✗



**RACKED TUBES DOMINO**  
PN: 186010305

Ordering product number

**186010303**

OneLab reference: [218.5071]

## 0.2ML MICROTUBE RACK DOMINO BUNDLE

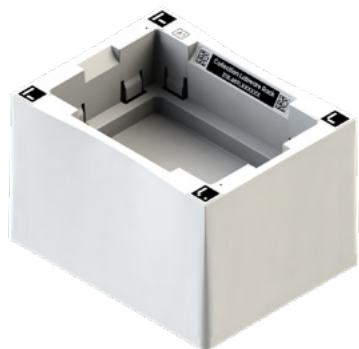

Collection Labware Rack Domino  
Ordering product number : 186010523

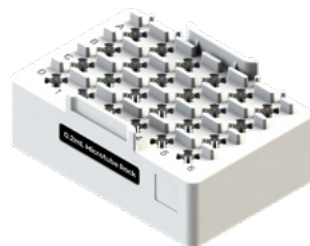

0.2 mL microtube 4x6 rack  
Rack not sold separately



Ordering product number

**186010303**



### IMPORTANT

The 0.2mL Microtube Rack Domino bundle consists of two components:  
The Collection Labware Rack Domino (186010523) and the 0.2 mL microtube 4x6 rack.  
The 0.2mL microtube 4x6 rack cannot be purchased separately and is only supplied  
with the 0.2mL microtube Rack Domino bundle (186010303).

# Thermo Scientific™ 0.2 mL PCR microtube, racked



**Manufacturer:**  
Thermo Scientific

**Part number:**  
AB0620



1-channel pipettes					
10 $\mu$ L	120 $\mu$ L	300 $\mu$ L	1000 $\mu$ L	5mL	10mL
✓	✓	✓	50	🧑	🧑

8-channel pipettes			
10 $\mu$ L	120 $\mu$ L	300 $\mu$ L	1200 $\mu$ L
✗	✗	✗	✗



**0.2ML MICROTUBE  
RACK DOMINO BUNDLE**  
PN: 186010303

Ordering product number

**186010161**

OneLab reference: [218.2841]

## 1.2ML MICROTUBE RACK DOMINO



The 1.2mL Microtube Rack Domino is specifically designed to hold a rack of 96 small-volume tubes.

**SEE THIS DOMINO  
ON OUR E-SHOP**

# STARLAB, 1.2 mL microtube in 96x rack



**Manufacturer:**  
STARLAB

**Part number:**  
I1412-0400

1-channel pipettes					
10 $\mu$ L	120 $\mu$ L	300 $\mu$ L	1000 $\mu$ L	5mL	10mL
✓	✓	✓	<b>700</b>	🧪	🧪

8-channel pipettes			
10 $\mu$ L	120 $\mu$ L	300 $\mu$ L	1200 $\mu$ L
✗	✗	✗	✗



**1.2ML MICROTUBE  
RACK DOMINO**  
PN: 186010161



Ordering product number

**186010174**

OneLab reference: [218.3421]

## BRAND® 1.2ML MICROTUBE RACK DOMINO



The BRAND® 1.2mL Microtube Rack Domino, is specifically designed to hold the consumable and rack configuration bearing the same name. A single rack can hold up to 96 microtubes.

**SEE THIS DOMINO  
ON OUR E-SHOP**

# BRAND® 1.2 mL 8-strip tubes in 96x rack



**Manufacturer:**  
BRAND

**Part number:**  
781510

## 1-channel pipettes

10 $\mu$ L	120 $\mu$ L	300 $\mu$ L	1000 $\mu$ L	5mL	10mL
<b>450</b>	<b>100</b>	<b>100</b>	<b>600</b>		

## 8-channel pipettes

10 $\mu$ L	120 $\mu$ L	300 $\mu$ L	1200 $\mu$ L
<b>450</b>	<b>100</b>	<b>100</b>	<b>450</b>



**BRAND® 1.2ML**  
**MICROTUBE**  
**RACK DOMINO**  
PN: 186010174

Ordering product number

**186010178**

OneLab reference: [218.3541]

## 2ML CRYOTUBE RACK DOMINO



The 2mL Cryotube Rack Domino is specifically designed to hold Cryotubes within a Waters 48x rack.

**SEE THIS DOMINO  
ON OUR E-SHOP**

# Cryo.s™ 2 mL external thread tube in Waters 48x holder



**Manufacturer:**  
Greiner Bio-One

**Part number:**  
126263

1-channel pipettes					
10µL	120µL	300µL	1000µL	5mL	10mL
✓	✓	✓	✓	✓	<b>1 000</b>

8-channel pipettes			
10µL	120µL	300µL	1200µL
✗	✗	✗	✗



**2ML CRYOTUBE**  
**RACK DOMINO**  
PN: 186010178

# VWR® 2 mL free-standing cryogenic vial in Waters 48x holder



**Manufacturer:**  
VWR International

**Part number:**  
479-1208

1-channel pipettes					
10µL	120µL	300µL	1000µL	5mL	10mL
✓	✓	✓	✓	✓	<b>1 000</b>

8-channel pipettes			
10µL	120µL	300µL	1200µL
✗	✗	✗	✗



**2ML CRYOTUBE  
RACK DOMINO**  
PN: 186010178

Ordering product number

**186010091**

OneLab reference: [218.3001]

## 2ML HPLC VIAL RACK DOMINO



The 2mL HPLC Vial Rack Domino is designed to hold in place a growing variety of racks commonly used to hold HPLC vials in various formats.

**SEE THIS DOMINO  
ON OUR E-SHOP**

# Agilent 2 mL 12x32mm crimp-top vial in Genevac 48x holder



**Manufacturer:**  
Agilent

**Part number:**  
5181-3375

1-channel pipettes					
10 $\mu$ L	120 $\mu$ L	300 $\mu$ L	1000 $\mu$ L	5mL	10mL
✓	✓	✓	1 000	⚠	⚠

8-channel pipettes			
10 $\mu$ L	120 $\mu$ L	300 $\mu$ L	1200 $\mu$ L
✗	✗	✗	✗



2ML HPLC VIAL  
RACK DOMINO  
PN: 186010091

# Agilent 2 mL 12x32mm crimp-top vial in Waters 48x holder



**Manufacturer:**  
Agilent

**Part number:**  
5181-3375

1-channel pipettes					
10 $\mu$ L	120 $\mu$ L	300 $\mu$ L	1000 $\mu$ L	5mL	10mL
✓	✓	✓	1 000	🧪	🧪

8-channel pipettes			
10 $\mu$ L	120 $\mu$ L	300 $\mu$ L	1200 $\mu$ L
✗	✗	✗	✗



2ML HPLC VIAL  
RACK DOMINO  
PN: 186010091



# Agilent 2 mL 12x32mm screw-top vial in Vanquish™ rack



**Manufacturer:**  
Agilent Technologies

**Part number:**  
5182-0715

1-channel pipettes					
10µL	120µL	300µL	1000µL	5mL	10mL
✓	✓	✓	1 500	1 500	🚫

  

8-channel pipettes			
10µL	120µL	300µL	1200µL
✗	✗	✗	✗



2ML HPLC VIAL  
RACK DOMINO  
PN: 186010091

# Agilent 12x32mm screw-top vial w/ 0.3 mL insert in Waters 48x holder

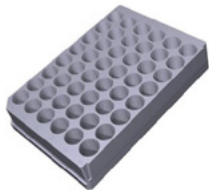

**Manufacturer:**  
Agilent Technologies

**Part number:**  
5188-6591

1-channel pipettes					
10 $\mu$ L	120 $\mu$ L	300 $\mu$ L	1000 $\mu$ L	5mL	10mL
35	✓	35	🚫	🚫	🚫

8-channel pipettes			
10 $\mu$ L	120 $\mu$ L	300 $\mu$ L	1200 $\mu$ L
✗	✗	✗	✗



2ML HPLC VIAL  
RACK DOMINO  
PN: 186010091

# Fisherbrand™ 1.5mL Amber Snap Ring Glass Vial



**Manufacturer:**  
Fisher Scientific

**Part number:**  
11090645

1-channel pipettes					
10µL	120µL	300µL	1000µL	5mL	10mL
✓	✓	✓	1 000	🧪	🧪

8-channel pipettes			
10µL	120µL	300µL	1200µL
✗	✗	✗	✗



2ML HPLC VIAL  
RACK DOMINO  
PN: 186010091

# Fisherbrand™ 1.5mL Clear Snap Ring Glass Vial



**Manufacturer:**  
Fisher Scientific

**Part number:**  
11535894

1-channel pipettes					
10µL	120µL	300µL	1000µL	5mL	10mL
✓	✓	✓	1 000	🧪	🧪

8-channel pipettes			
10µL	120µL	300µL	1200µL
✗	✗	✗	✗



2ML HPLC VIAL  
RACK DOMINO  
PN: 186010091

# Fisherbrand™ 2 mL straight-sided shell vial in Waters 48x holder



**Manufacturer:**  
Fisher Scientific

**Part number:**  
03-339-26A

1-channel pipettes					
10µL	120µL	300µL	1000µL	5mL	10mL
✓	✓	✓	✓	✓	<b>1 500</b>

8-channel pipettes			
10µL	120µL	300µL	1200µL
✗	✗	✗	✗



**2ML HPLC VIAL  
RACK DOMINO  
PN: 186010091**

# Interchim, 2 mL 12x32 mm screw-top glass vial in Waters 48x holder



**Manufacturer:**  
Interchim

**Part number:**  
723594

1-channel pipettes					
10 $\mu$ L	120 $\mu$ L	300 $\mu$ L	1000 $\mu$ L	5mL	10mL
✓	✓	✓	800	900	1 300

8-channel pipettes			
10 $\mu$ L	120 $\mu$ L	300 $\mu$ L	1200 $\mu$ L
✗	✗	✗	✗



2ML HPLC VIAL  
RACK DOMINO  
PN: 186010091

# Sarstedt, 1.2 mL QuickSeal screw-cap cryotube in Waters 48x holder



**Manufacturer:**  
Sarstedt

**Part number:**  
72.377.007

1-channel pipettes					
10 $\mu$ L	120 $\mu$ L	300 $\mu$ L	1000 $\mu$ L	5mL	10mL
✓	✓	✓	✓	✓	✓

8-channel pipettes			
10 $\mu$ L	120 $\mu$ L	300 $\mu$ L	1200 $\mu$ L
✗	✗	✗	✗



2ML HPLC VIAL  
RACK DOMINO  
PN: 186010091

# TPX snap/crimp-top vial w/ 0.2 mL glass micro-insert in Waters 48x holder



**Manufacturer:**

La-Pha-Pack GmbH

**Part number:**

11 14 1190

1-channel pipettes					
10µL	120µL	300µL	1000µL	5mL	10mL
20	20	40	200		

8-channel pipettes			
10µL	120µL	300µL	1200µL



2ML HPLC VIAL  
RACK DOMINO  
PN: 186010091



# Verex™ screw-top clear glass v-Vial in Waters 48x holder



**Manufacturer:**  
Phenomenex

**Part number:**  
AR0-3940-12

1-channel pipettes					
10µL	120µL	300µL	1000µL	5mL	10mL
20	✓	✓	500	600	🧪

8-channel pipettes			
10µL	120µL	300µL	1200µL
✗	✗	✗	✗



2ML HPLC VIAL  
RACK DOMINO  
PN: 186010091

# VWR® 1.2 mL internal thread cryogenic vial in Waters 48x holder



**Manufacturer:**  
VWR International

**Part number:**  
10018-738

1-channel pipettes					
10µL	120µL	300µL	1000µL	5mL	10mL
✓	✓	✓	✓	✓	✓

8-channel pipettes			
10µL	120µL	300µL	1200µL
✗	✗	✗	✗



2ML HPLC VIAL  
RACK DOMINO  
PN: 186010091

# VWR® 1.5 mL short thread vial w/ wide opening in Waters 48x holder



**Manufacturer:**  
VWR International

**Part number:**  
548-1848

1-channel pipettes					
10µL	120µL	300µL	1000µL	5mL	10mL
✓	✓	✓	1 500	1 500	🚫

8-channel pipettes			
10µL	120µL	300µL	1200µL
✗	✗	✗	✗



2ML HPLC VIAL  
RACK DOMINO  
PN: 186010091

# Waters 1 mL deactivated total recovery vial in Waters 48x holder



SEE THIS CONSUMABLE  
ON OUR E-SHOP

**Manufacturer:**  
Waters Corporation

**Part number:**  
186000234DV

1-channel pipettes					
10 $\mu$ L	120 $\mu$ L	300 $\mu$ L	1000 $\mu$ L	5mL	10mL
✓	✓	30	300	400	🧪

  

8-channel pipettes			
10 $\mu$ L	120 $\mu$ L	300 $\mu$ L	1200 $\mu$ L
✗	✗	✗	✗



2ML HPLC VIAL  
RACK DOMINO  
PN: 186010091

# Waters 1 mL LC/GC screw-top vial in 48x holder

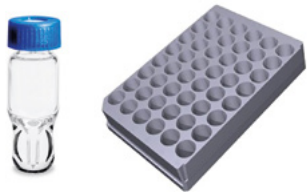

**Manufacturer:**  
Waters

**Part number:**  
186000385C

SEE THIS CONSUMABLE  
ON OUR E-SHOP

1-channel pipettes					
10 $\mu$ L	120 $\mu$ L	300 $\mu$ L	1000 $\mu$ L	5mL	10mL
✓	✓	✓	200	200	🚫

  

8-channel pipettes			
10 $\mu$ L	120 $\mu$ L	300 $\mu$ L	1200 $\mu$ L
✗	✗	✗	✗



2ML HPLC VIAL  
RACK DOMINO  
PN: 186010091

# Waters 2 mL 12x32 mm LC/GC screw-top vial in 48x holder

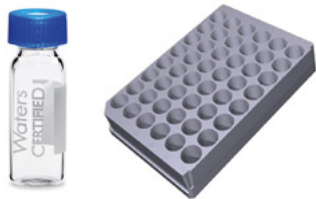

**Manufacturer:**  
Waters

**Part number:**  
186000272C

SEE THIS CONSUMABLE  
ON OUR E-SHOP

## 1-channel pipettes

10 $\mu$ L	120 $\mu$ L	300 $\mu$ L	1000 $\mu$ L	5mL	10mL
✓	✓	✓	1 000	🧪	🧪

## 8-channel pipettes

10 $\mu$ L	120 $\mu$ L	300 $\mu$ L	1200 $\mu$ L
✗	✗	✗	✗



2ML HPLC VIAL  
RACK DOMINO  
PN: 186010091

# Waters 2 mL deactivated amber glass screw-neck vial in 48x holder



**Manufacturer:**  
Waters Corporation

**Part number:**  
186000848DV

SEE THIS CONSUMABLE  
ON OUR E-SHOP

## 1-channel pipettes

10 $\mu$ L	120 $\mu$ L	300 $\mu$ L	1000 $\mu$ L	5mL	10mL
✓	✓	✓	1 500	🧪	🧪

## 8-channel pipettes

10 $\mu$ L	120 $\mu$ L	300 $\mu$ L	1200 $\mu$ L
✗	✗	✗	✗



2ML HPLC VIAL  
RACK DOMINO  
PN: 186010091

# Waters 300 $\mu$ L 12x32mm screw neck vial into 48x Waters rack



**Manufacturer:**  
Waters Corporation

**Part number:**  
186002639

SEE THIS CONSUMABLE  
ON OUR E-SHOP

## 1-channel pipettes

10 $\mu$ L	120 $\mu$ L	300 $\mu$ L	1000 $\mu$ L	5mL	10mL
15	✓	✓	60	100	

## 8-channel pipettes

10 $\mu$ L	120 $\mu$ L	300 $\mu$ L	1200 $\mu$ L
✗	✗	✗	✗



2ML HPLC VIAL  
RACK DOMINO  
PN: 186010091



# Waters 700 $\mu$ L 12x32mm screw neck vial into Waters 48x rack



**Manufacturer:**  
Waters Corporation

**Part number:**  
186005221

SEE THIS CONSUMABLE  
ON OUR E-SHOP

## 1-channel pipettes

10 $\mu$ L	120 $\mu$ L	300 $\mu$ L	1000 $\mu$ L	5mL	10mL
<b>100</b>	✓	✓	<b>300</b>	<b>300</b>	🧪

## 8-channel pipettes

10 $\mu$ L	120 $\mu$ L	300 $\mu$ L	1200 $\mu$ L
✗	✗	✗	✗



2ML HPLC VIAL  
RACK DOMINO  
PN: 186010091

Ordering product number

**186010319**

OneLab reference: [218.4671]

## VIALS W/ 24X RACK DOMINO



This Domino is a configuration composed of both a Domino and a specific rack designed to hold up to 24 vials with an exterior diameter of ~17mm. The rack is NOT compatible with the microplate gripper tool.

**SEE THIS DOMINO  
ON OUR E-SHOP**

# 5mL Neutral Type I glass diagnostic screw neck vial, racked



**Manufacturer:**  
SCHOTT Pharma

**Part number:**  
VCD005

## 1-channel pipettes

10 $\mu$ L	120 $\mu$ L	300 $\mu$ L	1000 $\mu$ L	5mL	10mL
✓	✓	✓	✓	<b>2 000</b>	<b>4 000</b>

## 8-channel pipettes

10 $\mu$ L	120 $\mu$ L	300 $\mu$ L	1200 $\mu$ L
✗	✗	✗	✗



**VIALS W/ 24X  
RACK DOMINO**  
PN: 186010319

# Supelco, graduated 7 mL screw-top glass vial in 24x rack



**Manufacturer:**  
Merck

**Part number:**  
27025

1-channel pipettes					
10 $\mu$ L	120 $\mu$ L	300 $\mu$ L	1000 $\mu$ L	5mL	10mL
✓	✓	✓	✓	6 500	8 000

8-channel pipettes			
10 $\mu$ L	120 $\mu$ L	300 $\mu$ L	1200 $\mu$ L
✗	✗	✗	✗



VIALS W/ 24X  
RACK DOMINO  
PN: 186010319

Ordering product number

**186010320**

OneLab reference: [218.4711]

## CULTURE TUBE W/ 48X RACK DOMINO



This Domino is a configuration composed of both a Domino and a specific rack designed to hold up to 48 vials with an exterior diameter of ~11.75mm. The rack is NOT compatible with the microplate gripper tool.

[SEE THIS DOMINO  
ON OUR E-SHOP](#)

# Disposable 6 mL culture tube with straight rim



CULTURE TUBE W/ 48X  
RACK DOMINO  
PN: 186010320

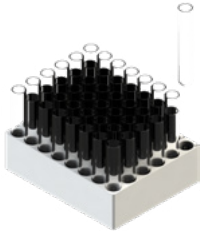

**Manufacturer:**  
DWK Life Sciences

**Part number:**  
231720862

## 1-channel pipettes

10 $\mu$ L	120 $\mu$ L	300 $\mu$ L	1000 $\mu$ L	5mL	10mL
✓	✓	✓	✓	✓	4 000

## 8-channel pipettes

10 $\mu$ L	120 $\mu$ L	300 $\mu$ L	1200 $\mu$ L
✗	✗	✗	✗

Ordering product number

**186010160**

OneLab reference: [218.5031]

## 15ML TUBE IN 15X RACK DOMINO



The 15mL Tube in 15x Rack Domino is specifically designed to hold a 3rd party rack (Cytiva: PN 28956404, sold separately) capable of holding up to 15 tubes.

**SEE THIS DOMINO  
ON OUR E-SHOP**

# Sarstedt, 15 mL conical tube in Cytiva 3x5 position cassette



**Manufacturer:**  
Sarstedt

**Part number:**  
62.554.001

1-channel pipettes					
10 $\mu$ L	120 $\mu$ L	300 $\mu$ L	1000 $\mu$ L	5mL	10mL
4 000	✓	✓	✓	✓	✓

8-channel pipettes			
10 $\mu$ L	120 $\mu$ L	300 $\mu$ L	1200 $\mu$ L
✗	✗	✗	✗



15ML TUBE IN 15X  
RACK DOMINO  
PN: 186010160



Ordering product number

**186010160**

OneLab reference: [218.2811]

## 60X 15ML CENTRIFUGE TUBE RACK DOMINO



The 60x 15mL Centrifuge Tube Rack Domino is specifically designed to hold a large format rack capable of holding up to 60 tubes. This Domino is a 1x2 format Domino. As of such, it takes 2 positions horizontally on the Andrew+ robot workbench.

**SEE THIS DOMINO  
ON OUR E-SHOP**

# 14mL Polypropylene Test Tube into Agilent 60 positions rack



**Manufacturer:**  
Agilent Technologies

**Part number:**  
3710051100

1-channel pipettes					
10 $\mu$ L	120 $\mu$ L	300 $\mu$ L	1000 $\mu$ L	5mL	10mL
5 000	2 000	2 000	✓	✓	✓

8-channel pipettes			
10 $\mu$ L	120 $\mu$ L	300 $\mu$ L	1200 $\mu$ L
✗	✗	✗	✗



60X 15ML CENTRIFUGE  
TUBE RACK DOMINO  
PN: 186010160

# Certifuge Tube 50mL into Agilent rack



**Manufacturer:**  
Environmental  
Express

**Part number:**  
UC475-GN

1-channel pipettes					
10 $\mu$ L	120 $\mu$ L	300 $\mu$ L	1000 $\mu$ L	5mL	10mL
✓	✓	✓	✓	✓	✓

8-channel pipettes			
10 $\mu$ L	120 $\mu$ L	300 $\mu$ L	1200 $\mu$ L
✗	✗	✗	✗



60X 15ML CENTRIFUGE  
TUBE RACK DOMINO  
PN: 186010160

# Falcon® 15 mL conical tube in Sapidyne 60x rack



**Manufacturer:**  
Corning Inc.

**Part number:**  
352096

1-channel pipettes					
10µL	120µL	300µL	1000µL	5mL	10mL
1 500	600	900	✓	✓	500

8-channel pipettes			
10µL	120µL	300µL	1200µL
✗	✗	✗	✗



60X 15ML CENTRIFUGE  
TUBE RACK DOMINO  
PN: 186010160

Ordering product number

**186010514**

OneLab reference: [218.4961]

## 50ML TUBE IN 55X RACK DOMINO

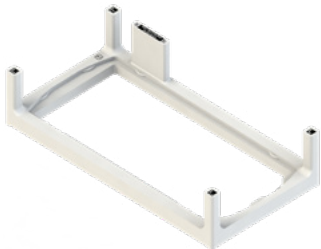

The 50mL Tube in 55x Rack Domino is specifically designed to hold a very large format rack capable of holding up to 55 tubes (Cytiva: PN 28980319, sold separately). This Domino is a 3x2 format Domino. As of such, it takes a total of 3 positions horizontally and 2 positions vertically on the Andrew+ robot workbench, equivalent to the space taken by 6 standard Dominos.

[SEE THIS DOMINO  
ON OUR E-SHOP](#)

# Sarstedt, 50 mL skirted conical tube in Cytiva 5x11 position rack



**Manufacturer:**  
Sarstedt

**Part number:**  
62.559.001

1-channel pipettes					
10 $\mu$ L	120 $\mu$ L	300 $\mu$ L	1000 $\mu$ L	5mL	10mL
4 000	✓	✓	✓	✓	✓

8-channel pipettes			
10 $\mu$ L	120 $\mu$ L	300 $\mu$ L	1200 $\mu$ L
✗	✗	✗	✗



50ML TUBE  
IN 55X RACK DOMINO  
PN: 186010514

Ordering product number

**186010515**

OneLab reference: [218.5001]

## 250ML BOTTLE IN 18X RACK DOMINO

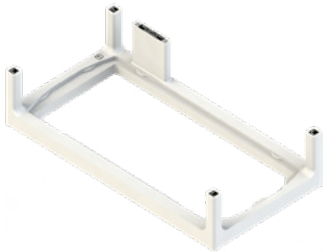

The 250mL Bottle in 18x Rack Domino is specifically designed to hold a very large format rack capable of holding up to 18 large bottles (Cytiva: PN 28981873, sold separately). This Domino is a 3x2 format Domino. As of such, it takes a total of 3 positions horizontally and 2 positions vertically on the Andrew+ robot workbench, equivalent to the space taken by 6 standard Dominos.

[SEE THIS DOMINO  
ON OUR E-SHOP](#)

# NOVOPLAST, 250 mL square bottle in Cytiva, 3x6 position rack



**Manufacturer:**  
NOVOPLAST

**Part number:**  
591.012.01.00

1-channel pipettes					
10 $\mu$ L	120 $\mu$ L	300 $\mu$ L	1000 $\mu$ L	5mL	10mL
50 000	✓	✓	✓	✓	✓

8-channel pipettes			
10 $\mu$ L	120 $\mu$ L	300 $\mu$ L	1200 $\mu$ L
✗	✗	✗	✗



250ML BOTTLE  
IN 18X RACK DOMINO  
PN: 186010515





# DEVICE+



Ordering product number

**176004577**

OneLab reference: [518.4000]

## MICROPLATE SHAKER+

### DIRECT COMPATIBILITY



The Microplate Shaker+ is a OneLab connected device that uses market-leading orbital shaking technology to ensure vibration-free mixing speeds up to 3000rpm. A growing array of labware are compatible with this device either directly or via dedicated racks.

**SEE THIS DEVICE  
ON OUR E-SHOP**

# 1.4mL Nova Biostorage tube into Matrix™ 2D rack



**Manufacturer:**  
Thermo Scientific

**Part number:**  
MP226RP

1-channel pipettes					
10µL	120µL	300µL	1000µL	5mL	10mL
✓	50	✓	600	600	800

  

8-channel pipettes			
10µL	120µL	300µL	1200µL
250	50	✓	✓



**MICROPLATE SHAKER+**  
Direct Compatibility  
PN: 176004577

# Abgene™ 0.8 mL 96-deep well storage plate

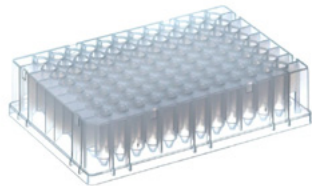

**Manufacturer:**  
Thermo Scientific

**Part number:**  
AB0859



1-channel pipettes					
10µL	120µL	300µL	1000µL	5mL	10mL
✓	✓	✓	50	200	40

  

8-channel pipettes			
10µL	120µL	300µL	1200µL
200	✓	✓	✓



**MICROPLATE SHAKER+**  
Direct Compatibility  
PN: 176004577

# ACC, Pyroclear<sup>®</sup> Pyroplate<sup>®</sup> 96-well microplate

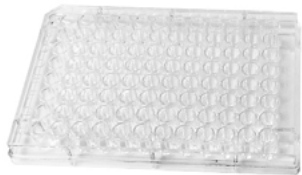

**Manufacturer:**  
Associates of Cape  
Cod, Inc.

**Part number:**  
CA961-50



1-channel pipettes					
10 $\mu$ L	120 $\mu$ L	300 $\mu$ L	1000 $\mu$ L	5mL	10mL
✓	✓	✓	✓	⚠	⚠

8-channel pipettes			
10 $\mu$ L	120 $\mu$ L	300 $\mu$ L	1200 $\mu$ L
✓	✓	✓	✓



**MICROPLATE SHAKER+**  
Direct Compatibility  
PN: 176004577

# Axygen® 1.1 mL 96-round deep well U-bottom plate



**Manufacturer:**  
Corning Inc.

**Part number:**  
P-DW-11-C



1-channel pipettes					
10µL	120µL	300µL	1000µL	5mL	10mL
✓	✓	✓	✓	✓	✓

8-channel pipettes			
10µL	120µL	300µL	1200µL
<b>300</b>	✓	✓	✓



**MICROPLATE SHAKER+**  
Direct Compatibility  
PN: 176004577

# Azenta 0.9 mL external thread dual-coded tube in 96x rack



**Manufacturer:**  
Azenta Life Sciences

**Part number:**  
68-1001-11

1-channel pipettes					
10 $\mu$ L	120 $\mu$ L	300 $\mu$ L	1000 $\mu$ L	5mL	10mL
✓	✓	✓	<b>600</b>		

  

8-channel pipettes			
10 $\mu$ L	120 $\mu$ L	300 $\mu$ L	1200 $\mu$ L
<b>500</b>	✓	✓	✓



**MICROPLATE SHAKER+**  
Direct Compatibility  
PN: 176004577

# CELLSTAR® 96-well clear F-bottom cell culture microplate

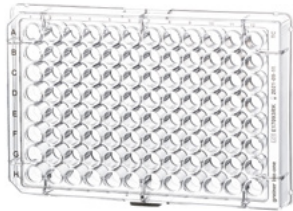

**Manufacturer:**  
Greiner Bio-One

**Part number:**  
655180



1-channel pipettes					
10µL	120µL	300µL	1000µL	5mL	10mL
✓	✓	✓	✓	⚠	⚠

8-channel pipettes			
10µL	120µL	300µL	1200µL
✓	✓	✓	✓



**MICROPLATE SHAKER+**  
Direct Compatibility  
PN: 176004577



# Corning® 2 mL 96-square deep well V-bottom plate



**Manufacturer:**  
Corning Inc.

**Part number:**  
3960



## 1-channel pipettes

10µL	120µL	300µL	1000µL	5mL	10mL
✓	✓	✓	✓	<b>700</b>	

## 8-channel pipettes

10µL	120µL	300µL	1200µL
<b>800</b>	✓	✓	✓



**MICROPLATE SHAKER+**  
Direct Compatibility  
PN: 176004577

# Eppendorf 0.5 mL 96-deep well protein LoBind® plate, yellow frame



**Manufacturer:**  
Eppendorf

**Part number:**  
0030504119



1-channel pipettes					
10µL	120µL	300µL	1000µL	5mL	10mL
✓	✓	✓	✓	✓	<b>300</b>

8-channel pipettes			
10µL	120µL	300µL	1200µL
<b>300</b>	✓	✓	✓



**MICROPLATE SHAKER+**  
Direct Compatibility  
PN: 176004577

# Eppendorf 1 mL 96-deep well protein LoBind<sup>®</sup> plate, yellow frame



**Manufacturer:**  
Eppendorf

**Part number:**  
0030504216



## 1-channel pipettes

10 $\mu$ L	120 $\mu$ L	300 $\mu$ L	1000 $\mu$ L	5mL	10mL
✓	✓	✓	<b>600</b>	<b>650</b>	

## 8-channel pipettes

10 $\mu$ L	120 $\mu$ L	300 $\mu$ L	1200 $\mu$ L
<b>500</b>	✓	✓	✓



**MICROPLATE SHAKER+**  
Direct Compatibility  
PN: 176004577

# Eppendorf 2 mL 96-square deep well plate, yellow frame



**Manufacturer:**  
Eppendorf

**Part number:**  
0030501314



1-channel pipettes					
10 $\mu$ L	120 $\mu$ L	300 $\mu$ L	1000 $\mu$ L	5mL	10mL
✓	✓	✓	✓	<b>700</b>	<b>1 300</b>

8-channel pipettes			
10 $\mu$ L	120 $\mu$ L	300 $\mu$ L	1200 $\mu$ L
<b>500</b>	✓	✓	✓



**MICROPLATE SHAKER+**  
Direct Compatibility  
PN: 176004577

# Eppendorf twin.tec® 96-well skirted LoBind® PCR plate



**Manufacturer:**  
Eppendorf

**Part number:**  
0030129555



1-channel pipettes					
10µL	120µL	300µL	1000µL	5mL	10mL
✓	✓	✓	✓	⚠	⚠

  

8-channel pipettes			
10µL	120µL	300µL	1200µL
✓	✓	✓	✓



**MICROPLATE SHAKER+**  
Direct Compatibility  
PN: 176004577

# FrameStar® 0.1 mL 96-well skirted low profile PCR plate, clear wells

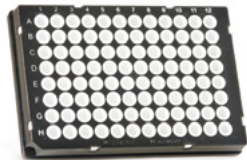

**Manufacturer:**  
Azenta Life Sciences

**Part number:**  
4ti-0960/RIG



1-channel pipettes					
10µL	120µL	300µL	1000µL	5mL	10mL
✓	✓	✓	✓	⚠	⚠

8-channel pipettes			
10µL	120µL	300µL	1200µL
✓	✓	✓	✓



**MICROPLATE SHAKER+**  
Direct Compatibility  
PN: 176004577

# Greiner, 96-well PP U-bottom clear microplate



**Manufacturer:**  
Greiner Bio-One

**Part number:**  
650261

1-channel pipettes					
10 $\mu$ L	120 $\mu$ L	300 $\mu$ L	1000 $\mu$ L	5mL	10mL
✓	✓	✓	✓	✓	✓

8-channel pipettes			
10 $\mu$ L	120 $\mu$ L	300 $\mu$ L	1200 $\mu$ L
✓	✓	✓	✓



**MICROPLATE SHAKER+**  
Direct Compatibility  
PN: 176004577

# Greiner, 96-well PS F-bottom clear microplate



**Manufacturer:**  
Greiner Bio-One

**Part number:**  
655101



1-channel pipettes					
10 $\mu$ L	120 $\mu$ L	300 $\mu$ L	1000 $\mu$ L	5mL	10mL
✓	✓	✓	✓	✗	✗

8-channel pipettes			
10 $\mu$ L	120 $\mu$ L	300 $\mu$ L	1200 $\mu$ L
✓	✓	✓	✓



**MICROPLATE SHAKER+**  
Direct Compatibility  
PN: 176004577



# Hard-Shell® 96-well low-profile skirted PCR plate, white/clear



**Manufacturer:**  
Bio-Rad

**Part number:**  
HSP9601



1-channel pipettes					
10µL	120µL	300µL	1000µL	5mL	10mL
✓	✓	✓	✓	⚠	⚠

8-channel pipettes			
10µL	120µL	300µL	1200µL
✓	✓	✓	✓



**MICROPLATE SHAKER+**  
Direct Compatibility  
PN: 176004577

# HardShell 96-well low-profile skirted PCR plate, blue/clear



**Manufacturer:**  
PerkinElmer, Inc.

**Part number:**  
6008870



1-channel pipettes					
10 $\mu$ L	120 $\mu$ L	300 $\mu$ L	1000 $\mu$ L	5mL	10mL
✓	✓	✓	✓	✗	✗

8-channel pipettes			
10 $\mu$ L	120 $\mu$ L	300 $\mu$ L	1200 $\mu$ L
✓	✓	✓	✓



**MICROPLATE SHAKER+**  
Direct Compatibility  
PN: 176004577

# Matrix™ ScrewTop Tri-coded Tubes into 96 positions rack



**Manufacturer:**  
Thermo Scientific

**Part number:**  
3742-WP1D-BR



1-channel pipettes					
10µL	120µL	300µL	1000µL	5mL	10mL
✓	✓	✓	650	550	800

  

8-channel pipettes			
10µL	120µL	300µL	1200µL
✓	✓	✓	40



**MICROPLATE SHAKER+**  
Direct Compatibility  
PN: 176004577

# MICROLON<sup>®</sup> 200 96-well U-bottom microplate

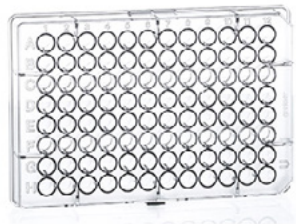

**Manufacturer:**  
Greiner Bio-One

**Part number:**  
650001

1-channel pipettes					
10 $\mu$ L	120 $\mu$ L	300 $\mu$ L	1000 $\mu$ L	5mL	10mL
✓	✓	✓	✓	⚠	⚠

8-channel pipettes			
10 $\mu$ L	120 $\mu$ L	300 $\mu$ L	1200 $\mu$ L
✓	✓	✓	✓



**MICROPLATE SHAKER+**  
Direct Compatibility  
PN: 176004577

# MultiScreen® Solvinert™ 96-well filter plate, 0.45 µm pore size



**Manufacturer:**  
Merck

**Part number:**  
MSRLN0450

1-channel pipettes					
10µL	120µL	300µL	1000µL	5mL	10mL
✓	✓	✓	✓	⚠	⚠

8-channel pipettes			
10µL	120µL	300µL	1200µL
✓	✓	✓	✓



**MICROPLATE SHAKER+**  
Direct Compatibility  
PN: 176004577

# Nunc™ 1.3 mL 96-DeepWell™ plate



**Manufacturer:**  
Thermo Scientific

**Part number:**  
260251



1-channel pipettes					
10µL	120µL	300µL	1000µL	5mL	10mL
✓	✓	✓	✓	✓	✓

8-channel pipettes			
10µL	120µL	300µL	1200µL
500	✓	✓	✓



**MICROPLATE SHAKER+**  
Direct Compatibility  
PN: 176004577

# Nunc™ 2 mL 96-DeepWell™ plate



**Manufacturer:**  
Thermo Scientific

**Part number:**  
278743



1-channel pipettes					
10µL	120µL	300µL	1000µL	5mL	10mL
✓	✓	✓	✓	<b>500</b>	<b>1 200</b>

8-channel pipettes			
10µL	120µL	300µL	1200µL
<b>500</b>	✓	✓	✓



**MICROPLATE SHAKER+**  
Direct Compatibility  
PN: 176004577

# Porvair, 2 mL 96-deep well U-bottom plate



**Manufacturer:**  
Porvair Sciences

**Part number:**  
219020



1-channel pipettes					
10 $\mu$ L	120 $\mu$ L	300 $\mu$ L	1000 $\mu$ L	5mL	10mL
✓	✓	✓	✓	1 000	1 500

8-channel pipettes			
10 $\mu$ L	120 $\mu$ L	300 $\mu$ L	1200 $\mu$ L
✓	✓	✓	✓



**MICROPLATE SHAKER+**  
Direct Compatibility  
PN: 176004577



# PreDictor MabSelect SuRe, 50 $\mu$ L 96-Well Plate



**Manufacturer:**  
Cytiva

**Part number:**  
28925825



1-channel pipettes					
10 $\mu$ L	120 $\mu$ L	300 $\mu$ L	1000 $\mu$ L	5mL	10mL
✓	✓	✓	300	300	🚫

8-channel pipettes			
10 $\mu$ L	120 $\mu$ L	300 $\mu$ L	1200 $\mu$ L
✓	✓	✓	✓



**MICROPLATE SHAKER+**  
Direct Compatibility  
PN: 176004577

# Riplate® Medio 1mL Deepwell Plate



**Manufacturer:**  
Carl Roth

**Part number:**  
TC22.1

1-channel pipettes					
10µL	120µL	300µL	1000µL	5mL	10mL
✓	✓	✓	✓	✓	✓

8-channel pipettes			
10µL	120µL	300µL	1200µL
450	✓	✓	✓



**MICROPLATE SHAKER+**  
Direct Compatibility  
PN: 176004577

# Thermo Scientific™ 0.3 mL 96-well U-bottom MaxiSorp Immuno plate



**Manufacturer:**  
Thermo Scientific

**Part number:**  
449824

1-channel pipettes					
10 $\mu$ L	120 $\mu$ L	300 $\mu$ L	1000 $\mu$ L	5mL	10mL
✓	✓	✓	✓	✓	✓

8-channel pipettes			
10 $\mu$ L	120 $\mu$ L	300 $\mu$ L	1200 $\mu$ L
✓	✓	✓	✓



**MICROPLATE SHAKER+**  
Direct Compatibility  
PN: 176004577

# Thermo Scientific™ 400 µL Immuno Standard black 16-well strips in 96x plate



**Manufacturer:**  
Thermo Scientific

**Part number:**  
475515

1-channel pipettes					
10µL	120µL	300µL	1000µL	5mL	10mL
✓	✓	✓	✓	✗	✗

8-channel pipettes			
10µL	120µL	300µL	1200µL
✓	✓	✓	✓



**MICROPLATE SHAKER+**  
Direct Compatibility  
PN: 176004577

# Waters 2 mL 96-square well collection plate, cut corner H1



SEE THIS CONSUMABLE  
ON OUR E-SHOP

**Manufacturer:**  
Waters

**Part number:**  
186002482



## 1-channel pipettes

10 $\mu$ L	120 $\mu$ L	300 $\mu$ L	1000 $\mu$ L	5mL	10mL
✓	✓	✓	✓	<b>300</b>	<b>850</b>

## 8-channel pipettes

10 $\mu$ L	120 $\mu$ L	300 $\mu$ L	1200 $\mu$ L
✓	✓	✓	✓



**MICROPLATE SHAKER+**  
Direct Compatibility  
PN: 176004577

# Waters 700 $\mu$ L 96-round well collection plate



SEE THIS CONSUMABLE  
ON OUR E-SHOP

**Manufacturer:**  
Waters

**Part number:**  
186005837



1-channel pipettes					
10 $\mu$ L	120 $\mu$ L	300 $\mu$ L	1000 $\mu$ L	5mL	10mL
✓	✓	✓	<b>100</b>	<b>100</b>	

8-channel pipettes			
10 $\mu$ L	120 $\mu$ L	300 $\mu$ L	1200 $\mu$ L
<b>200</b>	✓	✓	✓



**MICROPLATE SHAKER+**  
Direct Compatibility  
PN: 176004577

# Waters 800 $\mu$ L 96-round well collection plate



**SEE THIS CONSUMABLE  
ON OUR E-SHOP**

**Manufacturer:**  
Waters

**Part number:**  
186002481



1-channel pipettes					
10 $\mu$ L	120 $\mu$ L	300 $\mu$ L	1000 $\mu$ L	5mL	10mL
✓	✓	✓	<b>50</b>	<b>200</b>	<b>400</b>

8-channel pipettes			
10 $\mu$ L	120 $\mu$ L	300 $\mu$ L	1200 $\mu$ L
<b>200</b>	✓	✓	✓



**MICROPLATE SHAKER+**  
Direct Compatibility  
PN: 176004577

# Waters QuanRecovery™ 700 µL 96-well plate



**SEE THIS CONSUMABLE  
ON OUR E-SHOP**

**Manufacturer:**  
Waters

**Part number:**  
186009185



1-channel pipettes					
10µL	120µL	300µL	1000µL	5mL	10mL
✓	✓	✓	50	200	400

8-channel pipettes			
10µL	120µL	300µL	1200µL
200	✓	✓	✓



**MICROPLATE SHAKER+**  
Direct Compatibility  
PN: 176004577



# WebSeal 0.5 mL 96-well V-bottom plate



**Manufacturer:**  
Thermo Scientific

**Part number:**  
60180-P100



1-channel pipettes					
10 $\mu$ L	120 $\mu$ L	300 $\mu$ L	1000 $\mu$ L	5mL	10mL
✓	✓	✓	✓	⚠	⚠

8-channel pipettes			
10 $\mu$ L	120 $\mu$ L	300 $\mu$ L	1200 $\mu$ L
✓	✓	✓	✓



**MICROPLATE SHAKER+**  
Direct Compatibility  
PN: 176004577

# WebSeal 2 mL 96-deep well U-bottom plate



**Manufacturer:**  
Thermo Scientific

**Part number:**  
60180-P104



1-channel pipettes					
10 $\mu$ L	120 $\mu$ L	300 $\mu$ L	1000 $\mu$ L	5mL	10mL
✓	✓	✓	✓	1 000	1 000

8-channel pipettes			
10 $\mu$ L	120 $\mu$ L	300 $\mu$ L	1200 $\mu$ L
✓	✓	✓	✓



**MICROPLATE SHAKER+**  
Direct Compatibility  
PN: 176004577

Ordering product number

**176004577**

OneLab reference: [518.4000]

# MICROPLATE SHAKER+

EQUIPPED WITH 0.2ML MICROTUBE RACK (requires 186010303)

**24X**



Ordering product number

**186010534**

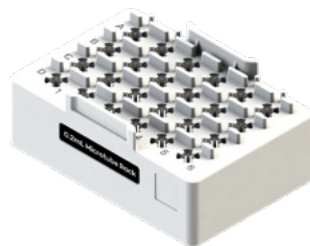

0.2mL Microtube Rack Domino

OneLab reference: [218.5071]



## IMPORTANT

Compatibility of the 0.2mL Microtube Rack with the Microplate Shaker+ Device requires the purchase of the 0.2mL Microtube Rack Domino bundle (186010303).

# Thermo Scientific™ 0.2 mL PCR microtube, racked



**Manufacturer:**  
Thermo Scientific

**Part number:**  
AB0620

1-channel pipettes					
10µL	120µL	300µL	1000µL	5mL	10mL
✓	✓	✓	50	🧪	🧪

8-channel pipettes			
10µL	120µL	300µL	1200µL
✗	✗	✗	✗

## IMPORTANT

Compatibility of the Thermo Scientific™ 0.2mL PCR microtubes with the Shaker+ device requires the purchase of the 0.2mL Microtube Rack Domino Bundle (186010303)



Ordering product number  
**186010303**



0.2mL Microtube Rack  
Domino Bundle



**MICROPLATE SHAKER+**  
Equipped with  
0.2mL Microtube Rack  
PN: 176004577  
+ 186010534

Ordering product number

**176004577**

OneLab reference: [518.4000]

# MICROPLATE SHAKER+

EQUIPPED WITH Ø12MM VIAL COLLECTION RACK



Ordering product number

**186010531**

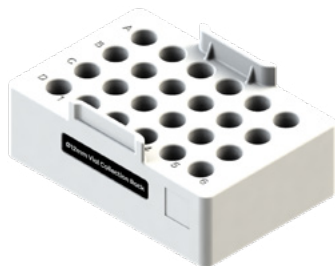

Ø12mm Vial Collection Rack

OneLab reference: [519.2601]



## IMPORTANT

The Ø12mm Vial Collection Rack (24-position rack) is manufactured by Waters Corporation and specifically designed for use with the **Extraction+** connected device.

The Ø12mm Vial Collection Rack is sold separately from the Microplate Shaker+. A Collection Labware Rack Domino is only required for this rack when an automated movement to/from the Shaker+ (using the plate gripper tool) is required.

# Waters 2 mL 12x32 mm LC/GC screw-top vial, racked



SEE THIS CONSUMABLE  
ON OUR E-SHOP

**Manufacturer:**  
Waters Corporation

**Part number:**  
186000272C



1-channel pipettes					
10 $\mu$ L	120 $\mu$ L	300 $\mu$ L	1000 $\mu$ L	5mL	10mL
✓	✓	✓	1 000	🚫	🚫

8-channel pipettes			
10 $\mu$ L	120 $\mu$ L	300 $\mu$ L	1200 $\mu$ L
✗	✗	✗	✗



+



**MICROPLATE SHAKER+**  
Compatibility via  
Ø12mm Vial Collection Rack  
PN: 186010523  
+ 186010531

# Waters 300 $\mu$ L 12x32mm screw neck vial, racked



SEE THIS CONSUMABLE  
ON OUR E-SHOP

**Manufacturer:**  
Waters Corporation

**Part number:**  
186002639



1-channel pipettes					
10 $\mu$ L	120 $\mu$ L	300 $\mu$ L	1000 $\mu$ L	5mL	10mL
✓	✓	✓	150	🧪	🧪

8-channel pipettes			
10 $\mu$ L	120 $\mu$ L	300 $\mu$ L	1200 $\mu$ L
✗	✗	✗	✗



**MICROPLATE SHAKER+**  
Compatibility via  
Ø12mm Vial Collection Rack  
PN: 186010523  
+ 186010531

# Waters 700 $\mu\text{L}$ 12x32mm screw neck vial, racked



SEE THIS CONSUMABLE  
ON OUR E-SHOP

**Manufacturer:**  
Waters Corporation

**Part number:**  
186005221



1-channel pipettes					
10 $\mu\text{L}$	120 $\mu\text{L}$	300 $\mu\text{L}$	1000 $\mu\text{L}$	5mL	10mL
✓	✓	✓	500	🧪	🧪

8-channel pipettes			
10 $\mu\text{L}$	120 $\mu\text{L}$	300 $\mu\text{L}$	1200 $\mu\text{L}$
✗	✗	✗	✗

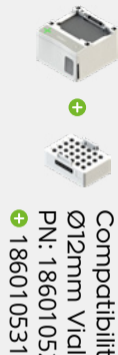

**MICROPLATE SHAKER+**  
Compatibility via  
Ø12mm Vial Collection Rack  
PN: 186010523  
+ 186010531



# Waters QuanRecovery™ 300 µL 12x32mm screw neck vial, racked



SEE THIS CONSUMABLE  
ON OUR E-SHOP

**Manufacturer:**  
Waters Corporation

**Part number:**  
186009186



1-channel pipettes					
10µL	120µL	300µL	1000µL	5mL	10mL
✓	✓	✓	150	🚫	🚫

8-channel pipettes			
10µL	120µL	300µL	1200µL
✗	✗	✗	✗



**MICROPLATE SHAKER+**  
Compatibility via  
Ø12mm Vial Collection Rack  
PN: 186010523  
+ 186010531

Ordering product number

**186010422**

OneLab reference: [518.4100]

## TUBE SHAKER+ W/ 12X75MM TUBE ADAPTOR



**WITH**

12x75mm Tube Adaptor OneLab reference: [518.3001]

The Tube Shaker+ is a OneLab connected device that uses market-leading orbital shaking technology to ensure vibration-free mixing speeds up to 2000rpm. Each Tube Shaker+ device is specifically designed to host dedicated tube types for maximum mixing efficiency.

**SEE THIS DEVICE  
ON OUR E-SHOP**

# Fisherbrand™ 6 mL round-bottom glass tube with plain end



**Manufacturer:**  
Fisher Scientific

**Part number:**  
14-961-26

1-channel pipettes					
10µL	120µL	300µL	1000µL	5mL	10mL
✓	✓	✓	✓	✓	✗

8-channel pipettes			
10µL	120µL	300µL	1200µL
✗	✗	✗	✗



**TUBE SHAKER+**  
**W/ 12X75MM**  
**TUBE ADAPTOR**  
PN: 186010422

Ordering product number

**176005077**

OneLab reference: [518.4100]

## TUBE SHAKER+ W/ 16X90MM TUBE ADAPTOR



**WITH**

16x90mm Tube Adaptor OneLab reference: [518.2501]

The Tube Shaker+ is a OneLab connected device that uses market-leading orbital shaking technology to ensure vibration-free mixing speeds up to 2000rpm. Each Tube Shaker+ device is specifically designed to host dedicated tube types for maximum mixing efficiency.

**SEE THIS DEVICE  
ON OUR E-SHOP**

# ACC, Pyrotube<sup>®</sup> 16x90mm depyrogenated glass tube



**Manufacturer:**

Associates of Cape  
Cod, Inc.

**Part number:**

TB16C

**1-channel pipettes**

10 $\mu$ L	120 $\mu$ L	300 $\mu$ L	1000 $\mu$ L	5mL	10mL
✓	✓	✓	✓	✓	✓

**8-channel pipettes**

10 $\mu$ L	120 $\mu$ L	300 $\mu$ L	1200 $\mu$ L
✗	✗	✗	✗



**TUBE SHAKER+  
W/ 16X90MM  
TUBE ADAPTOR**  
PN: 176005077

# BRAND® AR-GLAS® 13 mL 16x100mm culture tube



**Manufacturer:**  
BRAND

**Part number:**  
114115

1-channel pipettes					
10µL	120µL	300µL	1000µL	5mL	10mL
5 000	2 500	2 500	✓	✓	✓

8-channel pipettes			
10µL	120µL	300µL	1200µL
✗	✗	✗	✗



**TUBE SHAKER+  
W/ 16X90MM  
TUBE ADAPTOR**  
PN: 176005077

# Charles River, 16x90mm endotoxin-free glass tube



**Manufacturer:**  
Charles River

**Part number:**  
TL700

1-channel pipettes					
10 $\mu$ L	120 $\mu$ L	300 $\mu$ L	1000 $\mu$ L	5mL	10mL
✓	✓	✓	✓	✓	✗

8-channel pipettes			
10 $\mu$ L	120 $\mu$ L	300 $\mu$ L	1200 $\mu$ L
✗	✗	✗	✗



**TUBE SHAKER+**  
**W/ 16X90MM**  
**TUBE ADAPTOR**  
PN: 176005077

Ordering product number

**176005078**

OneLab reference: [518.4100]

## TUBE SHAKER+ W/ 5ML TUBE ADAPTOR



**WITH**

5mL Tube Adaptor OneLab reference: [518.2601]

The Tube Shaker+ is a OneLab connected device that uses market-leading orbital shaking technology to ensure vibration-free mixing speeds up to 2000rpm. Each Tube Shaker+ device is specifically designed to host dedicated tube types for maximum mixing efficiency.

**SEE THIS DEVICE  
ON OUR E-SHOP**



# EndoGrade<sup>®</sup> 5 mL glass test tube



**Manufacturer:**  
bioMérieux

**Part number:**  
800050

1-channel pipettes					
10 $\mu$ L	120 $\mu$ L	300 $\mu$ L	1000 $\mu$ L	5mL	10mL
✓	✓	✓	✓	✓	✓

8-channel pipettes			
10 $\mu$ L	120 $\mu$ L	300 $\mu$ L	1200 $\mu$ L
✗	✗	✗	✗



**TUBE SHAKER+**  
**W/ 5ML TUBE ADAPTOR**  
PN: 176005078

Ordering product number

**186010488**

OneLab reference: [518.4100]

## TUBE SHAKER+ WITH TILTED VIAL ADAPTOR



**WITH**

Tilted Vial Adaptor OneLab reference: [518.3221]

The Tube Shaker+ is a OneLab connected device that uses market-leading orbital shaking technology to ensure vibration-free mixing speeds up to 2000rpm. Each Tube Shaker+ device is specifically designed to host dedicated tube types for maximum mixing efficiency.

**E-SHOP AVAILABILITY  
COMING SOON**

# 10 mL crimp-top glass vial



**Manufacturer:**  
Associates of Cape  
Cod, Inc.

**Part number:**  
N/A

1-channel pipettes					
10 $\mu$ L	120 $\mu$ L	300 $\mu$ L	1000 $\mu$ L	5mL	10mL
✓	✓	✓	✓	⚠	⚠

8-channel pipettes			
10 $\mu$ L	120 $\mu$ L	300 $\mu$ L	1200 $\mu$ L
✗	✗	✗	✗



**TUBE SHAKER+ WITH  
TILTED VIAL ADAPTOR**  
PN: 186010488

Ordering product number

**186010489**

OneLab reference: [518.4300]

## TUBE SHAKER+ W/40ML TUBE ADAPTOR



The Tube Shaker+ is a OneLab connected device that uses market-leading orbital shaking technology to ensure vibration-free mixing speeds up to 2000rpm. Each Tube Shaker+ device is specifically designed to host dedicated tube types for maximum mixing efficiency.

**E-SHOP AVAILABILITY  
COMING SOON**

# Pre-cleaned VOA 40mL vials, Open top



**Manufacturer:**  
Shimadzu

**Part number:**  
REST-21796

1-channel pipettes					
10 $\mu$ L	120 $\mu$ L	300 $\mu$ L	1000 $\mu$ L	5mL	10mL
✓	✓	✓	✓	✓	✓

8-channel pipettes			
10 $\mu$ L	120 $\mu$ L	300 $\mu$ L	1200 $\mu$ L
✗	✗	✗	✗



**TUBE SHAKER+**  
**W/40ML TUBE ADAPTOR**  
PN: 186010489

Ordering product number

**176004852**

OneLab reference: [518.4500]

## MICROPLATE PELTIER+



The Microplate Peltier+ is a OneLab connected device that provides a compact all-in-one rapid heating and cooling solution for a growing variety of flat-bottom microplates. It can achieve and maintain temperatures ranging from 0-99°C.

**SEE THIS DEVICE  
ON OUR E-SHOP**

# CELLSTAR® 96-well clear F-bottom cell culture microplate

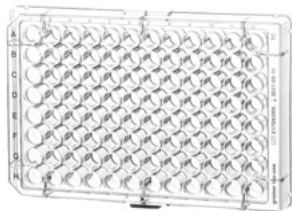

**Manufacturer:**  
Greiner Bio-One

**Part number:**  
655180



## 1-channel pipettes

10µL	120µL	300µL	1000µL	5mL	10mL
✓	✓	✓	✓	⚠	⚠

## 8-channel pipettes

10µL	120µL	300µL	1200µL
✓	✓	✓	✓



**MICROPLATE PELTIER+**  
PN: 176004852

# Greiner, 96-well PS F-bottom clear microplate



**Manufacturer:**  
Greiner Bio-One

**Part number:**  
655101



1-channel pipettes					
10 $\mu$ L	120 $\mu$ L	300 $\mu$ L	1000 $\mu$ L	5mL	10mL
✓	✓	✓	✓	⚠	⚠

8-channel pipettes			
10 $\mu$ L	120 $\mu$ L	300 $\mu$ L	1200 $\mu$ L
✓	✓	✓	✓



**MICROPLATE PELTIER+**  
PN: 176004852



# KingFisher™ 200uL Systems Consumable



**Manufacturer:**  
Thermo Scientific

**Part number:**  
97002084

1-channel pipettes					
10µL	120µL	300µL	1000µL	5mL	10mL
✓	✓	✓	✓	⚠	⚠

8-channel pipettes			
10µL	120µL	300µL	1200µL
✓	✓	✓	✓



**MICROPLATE PELTIER+**  
PN: 176004852

# Thermo Scientific™ 0.3 mL 96-well U-bottom MaxiSorp Immuno plate



**Manufacturer:**  
Thermo Scientific

**Part number:**  
449824

1-channel pipettes					
10µL	120µL	300µL	1000µL	5mL	10mL
✓	✓	✓	✓	✓	✓

8-channel pipettes			
10µL	120µL	300µL	1200µL
✓	✓	✓	✓



**MICROPLATE PELTIER+**  
PN: 176004852

# Thermo Scientific™ 400 $\mu$ L Immuno Standard black 16-well strips in 96x plate



**Manufacturer:**  
Thermo Scientific

**Part number:**  
475515

1-channel pipettes					
10 $\mu$ L	120 $\mu$ L	300 $\mu$ L	1000 $\mu$ L	5mL	10mL
✓	✓	✓	✓	⚠	⚠

  

8-channel pipettes			
10 $\mu$ L	120 $\mu$ L	300 $\mu$ L	1200 $\mu$ L
✓	✓	✓	✓



**MICROPLATE PELTIER+**  
PN: 176004852

# TPP 12-well tissue culture test plate

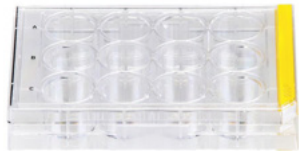

**Manufacturer:**  
TPP AG

**Part number:**  
92412



1-channel pipettes					
10 $\mu$ L	120 $\mu$ L	300 $\mu$ L	1000 $\mu$ L	5mL	10mL
✓	✓	✓	✓	✓	✓

8-channel pipettes			
10 $\mu$ L	120 $\mu$ L	300 $\mu$ L	1200 $\mu$ L
✗	✗	✗	✗



**MICROPLATE PELTIER+**  
PN: 176004852

Ordering product number

**176004584**

OneLab reference: [518.4600]

## 96-PCR PELTIER+



The 96-PCR Peltier+ is a OneLab connected device that provides a compact all-in-one rapid heating and cooling solution for a growing variety of PCR-type microplates. It can quickly achieve and maintain temperatures ranging from 0-99°C.

**SEE THIS DEVICE  
ON OUR E-SHOP**

# Axygen® 96-well PCR white microplate



**Manufacturer:**  
Starlab

**Part number:**  
PCR-96-LC480-W-NF

1-channel pipettes					
10µL	120µL	300µL	1000µL	5mL	10mL
✓	✓	✓	✓	40	60

8-channel pipettes			
10µL	120µL	300µL	1200µL
✓	✓	✓	✓



**96-PCR PELTIER+**  
PN: 176004584

# Eppendorf twin.tec® 96-well skirted LoBind® PCR plate



96-PCR PELTIER+  
PN: 176004584



**Manufacturer:**  
Eppendorf

**Part number:**  
0030129555



1-channel pipettes					
10µL	120µL	300µL	1000µL	5mL	10mL
✓	✓	✓	✓	⚠	⚠

  

8-channel pipettes			
10µL	120µL	300µL	1200µL
✗	✗	✗	✗

# FrameStar® 0.1 mL 96-well skirted low profile PCR plate, clear wells



96-PCR PELTIER+  
PN: 176004584

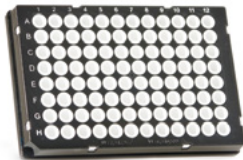

**Manufacturer:**  
Azenta Life Sciences

**Part number:**  
4ti-0960/RIG



1-channel pipettes					
10µL	120µL	300µL	1000µL	5mL	10mL
✓	✓	✓	✓	⚠	⚠

8-channel pipettes			
10µL	120µL	300µL	1200µL
✗	✗	✗	✗



# FrameStar® break-a-way PCR plate in 96x FrameStrip® adapter

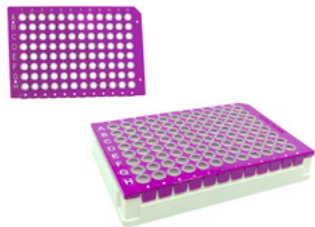

**Manufacturer:**  
Azenta Life Sciences

**Part number:**  
4ti-1000/P

1-channel pipettes					
10µL	120µL	300µL	1000µL	5mL	10mL
✓	✓	✓	✓	⚠	⚠

  

8-channel pipettes			
10µL	120µL	300µL	1200µL
✗	✗	✗	✗



**96-PCR PELTIER+**  
PN: 176004584

# FrameStrip® 8-well PCR tube strip in 96x FrameStrip® adapter

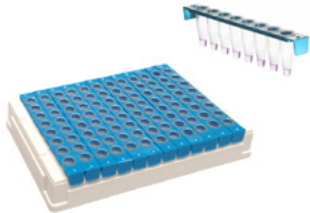

**Manufacturer:**  
Azenta Life Sciences

**Part number:**  
4ti-0786/B

1-channel pipettes					
10µL	120µL	300µL	1000µL	5mL	10mL
✓	✓	✓	✓	⚠	⚠

8-channel pipettes			
10µL	120µL	300µL	1200µL
✗	✗	✗	✗



**96-PCR PELTIER+**  
PN: 176004584

# Hard-Shell<sup>®</sup> 96-well low-profile skirted PCR plate, white/clear



## Manufacturer:

Bio-Rad

## Part number:

HSP9601



Compatible with  
Microplate  
Gripper

## 1-channel pipettes

10 $\mu$ L	120 $\mu$ L	300 $\mu$ L	1000 $\mu$ L	5mL	10mL
✓	✓	✓	✓	⚠	⚠

## 8-channel pipettes

10 $\mu$ L	120 $\mu$ L	300 $\mu$ L	1200 $\mu$ L
✗	✗	✗	✗



96-PCR PELTIER+  
PN: 176004584

# HardShell 96-well low-profile skirted PCR plate, blue/clear



**Manufacturer:**  
PerkinElmer, Inc.

**Part number:**  
6008870



1-channel pipettes					
10 $\mu$ L	120 $\mu$ L	300 $\mu$ L	1000 $\mu$ L	5mL	10mL
✓	✓	✓	✓	⚠	⚠

8-channel pipettes			
10 $\mu$ L	120 $\mu$ L	300 $\mu$ L	1200 $\mu$ L
✗	✗	✗	✗



**96-PCR PELTIER+**  
PN: 176004584

# MicroAmp™ 0.3 mL optical 96-well semi-skirted reaction plate



**Manufacturer:**  
Applied Biosystems

**Part number:**  
N8010560

1-channel pipettes					
10µL	120µL	300µL	1000µL	5mL	10mL
✓	✓	✓	100	🚫	🚫

8-channel pipettes			
10µL	120µL	300µL	1200µL
✗	✗	✗	✗



**96-PCR PELTIER+**  
PN: 176004584

# TempAssure<sup>®</sup> 0.2 mL 8-tube strip in Vari-Plate<sup>™</sup> 96x frame



**Manufacturer:**  
USA Scientific, Inc.

**Part number:**  
1402-2500

1-channel pipettes					
10 $\mu$ L	120 $\mu$ L	300 $\mu$ L	1000 $\mu$ L	5mL	10mL
✓	✓	✓	<b>100</b>	🚫	🚫

8-channel pipettes			
10 $\mu$ L	120 $\mu$ L	300 $\mu$ L	1200 $\mu$ L
✓	✓	✓	✓



**96-PCR PELTIER+**  
PN: 176004584

# Thermo Scientific™ 96-well non-skirted PCR plate



**Manufacturer:**  
Thermo Scientific

**Part number:**  
AB0600

1-channel pipettes					
10 $\mu$ L	120 $\mu$ L	300 $\mu$ L	1000 $\mu$ L	5mL	10mL
✓	✓	✓	✓	⚠	⚠

8-channel pipettes			
10 $\mu$ L	120 $\mu$ L	300 $\mu$ L	1200 $\mu$ L
✓	✓	✓	✓



**96-PCR PELTIER+**  
PN: 176004584

Ordering product number

**176004850**

OneLab reference: [518.5600]

## 96-PCR MAGNET+



The 96-PCR Magnet+ is a OneLab connected device that provides a simple and reliable way of fully automating the purification of genomic, plasmid and mitochondrial DNA using magnetic beads in small-volume plates. An automated moving shelf strategically positions magnets close to the bottom sides of consumables to optimize bead pelleting. The Andrew+ robot automatically and intelligently positions pipettes during pipetting steps with the Magnet+ so as to optimize purification workflows by not only avoiding the disturbance of pellets during pelleting phases, but also ensuring vigorous resuspension when necessary.

**SEE THIS DEVICE  
ON OUR E-SHOP**



# Eppendorf twin.tec® 96-well skirted LoBind® PCR plate



**Manufacturer:**  
Eppendorf

**Part number:**  
0030129555



Compatible with  
Microplate  
Gripper

## 1-channel pipettes

10µL	120µL	300µL	1000µL	5mL	10mL
✓	✓	✓	✓	⚠	⚠

## 8-channel pipettes

10µL	120µL	300µL	1200µL
✓	✓	✓	✓



**96-PCR MAGNET+**  
PN: 176004850

# FrameStar® 0.1 mL 96-well skirted low profile PCR plate, clear wells



96-PCR MAGNET+  
PN: 176004850

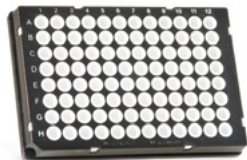

**Manufacturer:**  
Azenta Life Sciences

**Part number:**  
4ti-0960/RIG



## 1-channel pipettes

10µL	120µL	300µL	1000µL	5mL	10mL
✓	✓	✓	✓	⚠	⚠

## 8-channel pipettes

10µL	120µL	300µL	1200µL
✓	✓	✓	✓

# Hard-Shell<sup>®</sup> 96-well low-profile skirted PCR plate, white/clear



**Manufacturer:**  
Bio-Rad

**Part number:**  
HSP9601



1-channel pipettes					
10µL	120µL	300µL	1000µL	5mL	10mL
✓	✓	✓	✓	⚠	⚠

8-channel pipettes			
10µL	120µL	300µL	1200µL
✓	✓	✓	✓



**96-PCR MAGNET+**  
PN: 176004850

Ordering product number

**176004854**

OneLab reference: [518.5700]

## DEEPWELL MAGNET+



The Deepwell Magnet+ is a OneLab connected device that provides a simple and reliable way of fully automating the purification of genomic, plasmid and mitochondrial DNA using magnetic beads in deepwell plates. An automated moving shelf strategically positions magnets close to the bottom sides of consumables to optimize bead pelleting. In parallel, the Andrew+ robot automatically and intelligently positions pipettes during pipetting steps with the Magnet+ so as to optimize purification workflows by not only avoiding the disturbance of pellets during pelleting phases, but also ensuring vigorous resuspension when necessary.

[SEE THIS DEVICE  
ON OUR E-SHOP](#)

# Abgene™ 0.8 mL 96-deep well storage plate

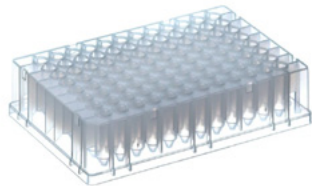

**Manufacturer:**  
Thermo Scientific

**Part number:**  
AB0859



1-channel pipettes					
10µL	120µL	300µL	1000µL	5mL	10mL
✓	✓	✓	50	200	400

8-channel pipettes			
10µL	120µL	300µL	1200µL
200	✓	✓	✓



**DEEPWELL MAGNET+**  
PN: 176004854

# Axygen® 1.1 mL 96-round deep well U-bottom plate



**Manufacturer:**  
Corning Inc.

**Part number:**  
P-DW-11-C



1-channel pipettes					
10µL	120µL	300µL	1000µL	5mL	10mL
✓	✓	✓	✓	✓	✓

8-channel pipettes			
10µL	120µL	300µL	1200µL
<b>300</b>	✓	✓	✓



**DEEPWELL MAGNET+**  
PN: 176004854

# Corning® 2 mL 96-square deep well V-bottom plate



**Manufacturer:**  
Corning Inc.

**Part number:**  
3960



1-channel pipettes					
10µL	120µL	300µL	1000µL	5mL	10mL
✓	✓	✓	✓	<b>700</b>	

8-channel pipettes			
10µL	120µL	300µL	1200µL
<b>800</b>	✓	✓	✓



**DEEPPWELL MAGNET+**  
PN: 176004854

# Eppendorf 2 mL 96-deep well protein LoBind® plate, white frame



**Manufacturer:**  
Eppendorf

**Part number:**  
0030504305



1-channel pipettes					
10µL	120µL	300µL	1000µL	5mL	10mL
✓	✓	✓	✓	<b>700</b>	<b>1 300</b>

8-channel pipettes			
10µL	120µL	300µL	1200µL
<b>900</b>	✓	✓	✓



**DEEPPWELL MAGNET+**  
PN: 176004854



# Eppendorf 2 mL 96-square deep well plate, yellow frame



**Manufacturer:**  
Eppendorf

**Part number:**  
0030501314



Compatible with  
Microplate  
Gripper

## 1-channel pipettes

10 $\mu$ L	120 $\mu$ L	300 $\mu$ L	1000 $\mu$ L	5mL	10mL
✓	✓	✓	✓	<b>700</b>	<b>1 300</b>

## 8-channel pipettes

10 $\mu$ L	120 $\mu$ L	300 $\mu$ L	1200 $\mu$ L
<b>500</b>	✓	✓	✓



**DEEPWELL MAGNET+**  
PN: 176004854

# KingFisher 96-deep well V-bottom plate



**Manufacturer:**  
Thermo Scientific

**Part number:**  
95040450



1-channel pipettes					
10 $\mu$ L	120 $\mu$ L	300 $\mu$ L	1000 $\mu$ L	5mL	10mL
✓	✓	✓	✓	<b>700</b>	<b>1 300</b>

8-channel pipettes			
10 $\mu$ L	120 $\mu$ L	300 $\mu$ L	1200 $\mu$ L
<b>500</b>	✓	✓	✓



**DEEPWELL MAGNET+**  
PN: 176004854

# Nunc™ 1.3 mL 96-DeepWell™ plate



**Manufacturer:**  
Thermo Scientific

**Part number:**  
260251



Compatible with  
Microplate  
Gripper

## 1-channel pipettes

10 $\mu$ L	120 $\mu$ L	300 $\mu$ L	1000 $\mu$ L	5mL	10mL
✓	✓	✓	✓	✓	✓

## 8-channel pipettes

10 $\mu$ L	120 $\mu$ L	300 $\mu$ L	1200 $\mu$ L
<b>500</b>	✓	✓	✓



**DEEPWELL MAGNET+**  
PN: 176004854

# Nunc™ 2 mL 96-DeepWell™ plate



**Manufacturer:**  
Thermo Scientific

**Part number:**  
278743



1-channel pipettes					
10µL	120µL	300µL	1000µL	5mL	10mL
✓	✓	✓	✓	<b>500</b>	<b>1 200</b>

8-channel pipettes			
10µL	120µL	300µL	1200µL
<b>500</b>	✓	✓	✓



**DEEPWELL MAGNET+**  
PN: 176004854

# Waters 700 $\mu$ L 96-round well collection plate



SEE THIS CONSUMABLE  
ON OUR E-SHOP

**Manufacturer:**  
Waters

**Part number:**  
186005837



## 1-channel pipettes

10 $\mu$ L	120 $\mu$ L	300 $\mu$ L	1000 $\mu$ L	5mL	10mL
✓	✓	✓	<b>100</b>	<b>100</b>	

## 8-channel pipettes

10 $\mu$ L	120 $\mu$ L	300 $\mu$ L	1200 $\mu$ L
<b>200</b>	✓	✓	✓



**DEEPWELL MAGNET+**  
PN: 176004854

# Waters 800 $\mu$ L 96-round well collection plate



SEE THIS CONSUMABLE  
ON OUR E-SHOP

**Manufacturer:**  
Waters

**Part number:**  
186002481



1-channel pipettes					
10 $\mu$ L	120 $\mu$ L	300 $\mu$ L	1000 $\mu$ L	5mL	10mL
✓	✓	✓	50	200	400

8-channel pipettes			
10 $\mu$ L	120 $\mu$ L	300 $\mu$ L	1200 $\mu$ L
200	✓	✓	✓



**DEEPWELL MAGNET+**  
PN: 176004854

# Waters QuanRecovery™ 700 µL 96-well plate



SEE THIS CONSUMABLE  
ON OUR E-SHOP

**Manufacturer:**  
Waters

**Part number:**  
186009185



1-channel pipettes					
10µL	120µL	300µL	1000µL	5mL	10mL
✓	✓	✓	50	200	400

8-channel pipettes			
10µL	120µL	300µL	1200µL
200	✓	✓	✓



**DEEPWELL MAGNET+**  
PN: 176004854

Ordering product number

**176004851**

OneLab reference: [518.5500]

## 50ML TUBE MAGNET+



The 50mL Tube Magnet+ is a OneLab connected device that provides a simple and reliable way of fully automating the purification of genomic, plasmid and mitochondrial DNA using magnetic beads in mid-size tubes. An automated moving shelf automatically and strategically moves magnets across a wide surface of the tubes found within the device in order to optimize bead pelleting performance. In parallel, the Andrew+ robot automatically and intelligently positions pipettes during pipetting steps with the Magnet+ so as to optimize purification workflows by not only avoiding the disturbance of pellets during pelleting phases, but also ensuring vigorous resuspension when necessary.

[SEE THIS DEVICE  
ON OUR E-SHOP](#)



# Corning® 50 mL conical centrifuge tube



**Manufacturer:**  
Corning Inc.

**Part number:**  
430290

1-channel pipettes					
10 $\mu$ L	120 $\mu$ L	300 $\mu$ L	1000 $\mu$ L	5mL	10mL
✓	✓	✓	✓	✓	✓

8-channel pipettes			
10 $\mu$ L	120 $\mu$ L	300 $\mu$ L	1200 $\mu$ L
✗	✗	✗	✗



**50mL TUBE MAGNET+**  
PN: 176004851

# Falcon® 50 mL conical centrifuge tube



**Manufacturer:**  
Corning Inc.

**Part number:**  
352070

1-channel pipettes					
10µL	120µL	300µL	1000µL	5mL	10mL
✓	✓	✓	✓	✓	✓

8-channel pipettes			
10µL	120µL	300µL	1200µL
✗	✗	✗	✗



**50ML TUBE MAGNET+**  
PN: 176004851

# Nunc™ 50 mL conical centrifuge tube



**Manufacturer:**  
Thermo Scientific

**Part number:**  
339652

1-channel pipettes					
10 $\mu$ L	120 $\mu$ L	300 $\mu$ L	1000 $\mu$ L	5mL	10mL
✓	✓	✓	✓	✓	✓

8-channel pipettes			
10 $\mu$ L	120 $\mu$ L	300 $\mu$ L	1200 $\mu$ L
✗	✗	✗	✗



**50ML TUBE MAGNET+**  
PN: 176004851

# VWR® 50 mL conical centrifuge tube



**Manufacturer:**  
VWR International

**Part number:**  
525-0610

1-channel pipettes					
10µL	120µL	300µL	1000µL	5mL	10mL
✓	✓	✓	✓	✓	✓

8-channel pipettes			
10µL	120µL	300µL	1200µL
✗	✗	✗	✗



**50ML TUBE MAGNET+**  
PN: 176004851

Ordering product number

**VARIABLE**

OneLab reference: [518.4200]

## HEATER-SHAKER+

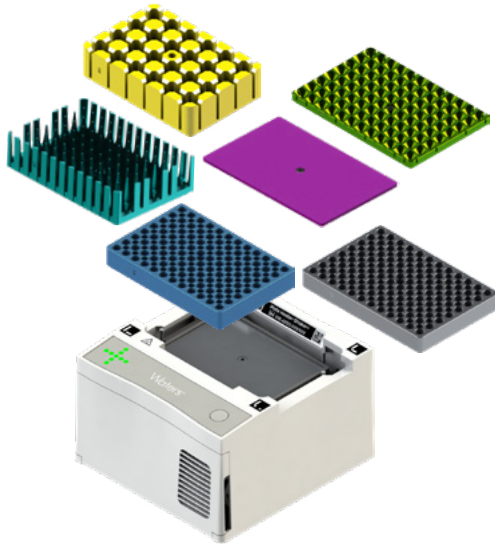

The Heater-Shaker+ device provides high-speed mixing & temperature control for the most demanding applications. This uniquely designed compact device is suitable for a wide range of labware thanks to its interchangeable adaptors. It combines both heating (from ambient to 99 °C) and vibration-free shaking (from 200 up to 2,500 rpm). Maximum recommended shaking speeds depend on the adaptor that the device is equipped with.

Ordering product number

**176005079**

OneLab reference: [518.4200]

# HEATER-SHAKER+ W/ LOW-PROFILE PLATE ADAPTER

EQUIPPED WITH LOW-PROFILE PLATE ADAPTOR

96X

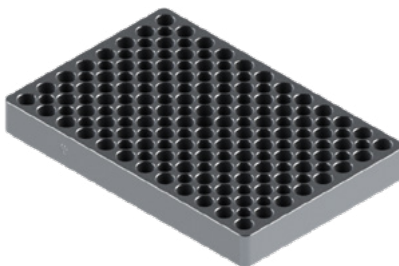

Low-Profile 96-PCR Plate Adaptor,  
Engraved Marking Code #B  
OneLab reference: [518.2701]

SEE THIS DEVICE  
ON OUR E-SHOP

# Eppendorf twin.tec® 96-well skirted LoBind® PCR plate



## Manufacturer:

Eppendorf

## Part number:

30129555



## 1-channel pipettes

10µL	120µL	300µL	1000µL	5mL	10mL
✓	✓	✓	✓	✗	✗

## 8-channel pipettes

10µL	120µL	300µL	1200µL
✓	✓	✓	✓



**HEATER-SHAKER+**  
Equipped with  
Low-Profile Plate Adaptor  
PN: 176005079  
+ 700013336

Ordering product number

**176005080**

OneLab reference: [518.4200]

# HEATER-SHAKER+ W/ HIGH-PROFILE PLATE ADAPTER

EQUIPPED WITH HIGH-PROFILE PLATE ADAPTOR

96X



Ordering product number

**700013336**

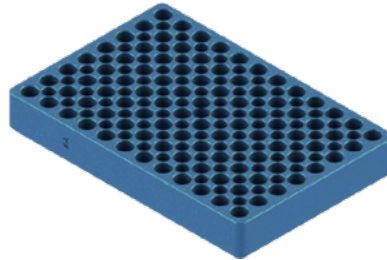

High-Profile 96-PCR Plate Adaptor,  
Engraved Marking Code #A  
OneLab reference: [518.2801]



SEE THIS DEVICE  
ON OUR E-SHOP



# FrameStar® break-a-way PCR plate in 96x FrameStrip® adapter

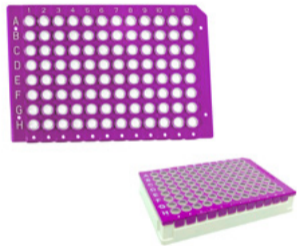

**Manufacturer:**  
Azenta Life Sciences

**Part number:**  
4ti-1000/P

## 1-channel pipettes

10 $\mu$ L	120 $\mu$ L	300 $\mu$ L	1000 $\mu$ L	5mL	10mL
✓	✓	✓	✓	✗	✗

## 8-channel pipettes

10 $\mu$ L	120 $\mu$ L	300 $\mu$ L	1200 $\mu$ L
✓	✓	✓	✓



**HEATER-SHAKER+**  
Equipped with  
High-Profile Plate Adaptor  
PN: 176005080  
+ 700013336

# FrameStrip® 8-well PCR tube strip in 96x FrameStrip® adapter

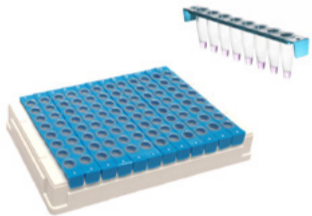

**Manufacturer:**  
Azenta Life Sciences

**Part number:**  
4ti-0786/B

1-channel pipettes					
10µL	120µL	300µL	1000µL	5mL	10mL
✓	✓	✓	✓	✗	✗

8-channel pipettes			
10µL	120µL	300µL	1200µL
✓	✓	✓	✓



**HEATER-SHAKER+**  
Equipped with  
High-Profile Plate Adaptor  
PN: 176005080  
+ 700013336

Ordering product number

**186010426**

OneLab reference: [518.4200]

# HEATER-SHAKER+ W/ DEEPWELL PLATE ADAPTOR

EQUIPPED WITH DEEPWELL PLATE ADAPTOR

96X



Ordering product number

**186010425**

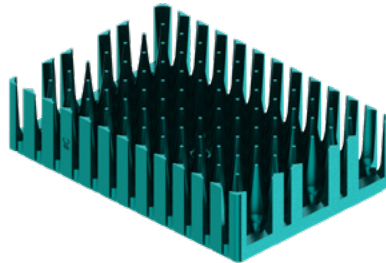

96-Deepwell Plate Adaptor,  
Engraved Marking Code #C  
OneLab reference: [518.3131]

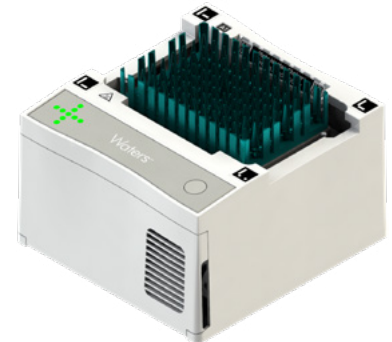

SEE THIS DEVICE  
ON OUR E-SHOP

# Abgene™ 0.8 mL 96-deep well storage plate

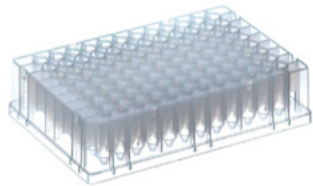

**Manufacturer:**  
Thermo Scientific

**Part number:**  
AB0859



1-channel pipettes					
10 $\mu$ L	120 $\mu$ L	300 $\mu$ L	1000 $\mu$ L	5mL	10mL
✓	✓	✓	50	200	400

8-channel pipettes			
10 $\mu$ L	120 $\mu$ L	300 $\mu$ L	1200 $\mu$ L
200	✓	✓	✓



**HEATER-SHAKER+**  
Equipped with  
Deepwell Plate Adaptor  
PN: 186010426  
+ 186010425

# Eppendorf 0.5 mL 96-deep well protein LoBind® plate, yellow frame



## Manufacturer:

Eppendorf

## Part number:

0030504119



Compatible with  
Microplate  
Gripper

## 1-channel pipettes

10 $\mu$ L	120 $\mu$ L	300 $\mu$ L	1000 $\mu$ L	5mL	10mL
✓	✓	✓	✓	✓	<b>300</b>

## 8-channel pipettes

10 $\mu$ L	120 $\mu$ L	300 $\mu$ L	1200 $\mu$ L
<b>300</b>	✓	✓	✓



**HEATER-SHAKER+**  
Equipped with  
Deepwell Plate Adaptor  
PN: 186010426  
+ 186010425

# Eppendorf 1 mL 96-deep well protein LoBind® plate, yellow frame



## Manufacturer:

Eppendorf

## Part number:

0030504216



Compatible with  
Microplate  
Gripper

## 1-channel pipettes

10 $\mu$ L	120 $\mu$ L	300 $\mu$ L	1000 $\mu$ L	5mL	10mL
✓	✓	✓	<b>600</b>	<b>650</b>	

## 8-channel pipettes

10 $\mu$ L	120 $\mu$ L	300 $\mu$ L	1200 $\mu$ L
<b>500</b>	✓	✓	✓



**HEATER-SHAKER+**  
Equipped with  
Deepwell Plate Adaptor  
PN: 186010426  
+ 186010425

# Waters 800 $\mu$ L 96-round well collection plate



SEE THIS CONSUMABLE  
ON OUR E-SHOP

**Manufacturer:**  
Waters Corporation

**Part number:**  
186002481



1-channel pipettes					
10 $\mu$ L	120 $\mu$ L	300 $\mu$ L	1000 $\mu$ L	5mL	10mL
✓	✓	✓	50	200	400

8-channel pipettes			
10 $\mu$ L	120 $\mu$ L	300 $\mu$ L	1200 $\mu$ L
200	✓	✓	✓



**HEATER-SHAKER+**  
Equipped with  
Deepwell Plate Adaptor  
PN: 186010426  
+ 186010425

# Waters QuanRecovery™ 700 µL 96-well plate



SEE THIS CONSUMABLE  
ON OUR E-SHOP

**Manufacturer:**  
Waters Corporation

**Part number:**  
186009185



1-channel pipettes					
10µL	120µL	300µL	1000µL	5mL	10mL
✓	✓	✓	50	200	400

8-channel pipettes			
10µL	120µL	300µL	1200µL
200	✓	✓	✓



**HEATER-SHAKER+**  
Equipped with  
Deepwell Plate Adaptor  
PN: 186010426  
+ 186010425



Ordering product number

**186010495**

OneLab reference: [518.4200]

# HEATER-SHAKER+ W/ FLAT-BOTTOM PLATE ADAPTER

EQUIPPED WITH FLAT-BOTTOM PLATE ADAPTOR



Ordering product number

**186010425**

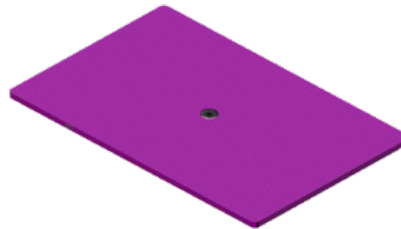

Flat-bottom Plate Adaptor,  
Engraved Marking Code #D  
OneLab reference: [518.3211]



**E-SHOP AVAILABILITY  
COMING SOON**

# 24-well plate with glass bottom



**Manufacturer:**  
Cellvis

**Part number:**  
P24-1.5H-N

1-channel pipettes					
10 $\mu$ L	120 $\mu$ L	300 $\mu$ L	1000 $\mu$ L	5mL	10mL
✓	✓	✓	✓	✓	✓

8-channel pipettes			
10 $\mu$ L	120 $\mu$ L	300 $\mu$ L	1200 $\mu$ L
✗	✗	✗	✗



**HEATER-SHAKER+**

Equipped with

Flat-Bottom Plate Adaptor

PN: 186010495

+ 186010425

# 96-well plate with glass bottom



**Manufacturer:**

Cellvis

**Part number:**

P96-1.5H-N

**1-channel pipettes**

10 $\mu$ L	120 $\mu$ L	300 $\mu$ L	1000 $\mu$ L	5mL	10mL
✓	✓	✓	✓	✓	✗

**8-channel pipettes**

10 $\mu$ L	120 $\mu$ L	300 $\mu$ L	1200 $\mu$ L
✓	✓	✓	✓



**HEATER-SHAKER+**

Equipped with

Flat-Bottom Plate Adaptor

PN: 186010495

+ 186010425

# ACC, Pyroclear<sup>®</sup> Pyroplate<sup>®</sup> 96-well microplate



**Manufacturer:**  
Associates of Cape  
Cod, Inc.

**Part number:**  
CA961-50



1-channel pipettes					
10 $\mu$ L	120 $\mu$ L	300 $\mu$ L	1000 $\mu$ L	5mL	10mL
✓	✓	✓	✓	⚠	⚠

  

8-channel pipettes			
10 $\mu$ L	120 $\mu$ L	300 $\mu$ L	1200 $\mu$ L
✓	✓	✓	✓



**HEATER-SHAKER+**  
Equipped with  
Flat-Bottom Plate Adaptor  
PN: 186010495  
+ 186010425

# CELLSTAR® 96-well clear F-bottom cell culture microplate

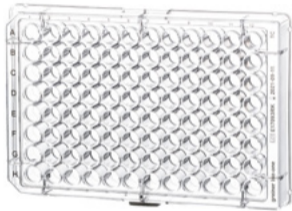

**Manufacturer:**  
Greiner Bio-One

**Part number:**  
655180



1-channel pipettes					
10µL	120µL	300µL	1000µL	5mL	10mL
✓	✓	✓	✓	✗	✗

8-channel pipettes			
10µL	120µL	300µL	1200µL
✓	✓	✓	✓



**HEATER-SHAKER+**  
Equipped with  
Flat-Bottom Plate Adaptor  
PN: 186010495  
+ 186010425

# Corning® 96-well Half Area, Glass Bottom Microplate



**Manufacturer:**

Corning Inc.

**Part number:**

4580

1-channel pipettes					
10 $\mu$ L	120 $\mu$ L	300 $\mu$ L	1000 $\mu$ L	5mL	10mL
✓	✓	✓	✓	⚠	⚠

8-channel pipettes			
10 $\mu$ L	120 $\mu$ L	300 $\mu$ L	1200 $\mu$ L
✗	✗	✗	✗



**HEATER-SHAKER+**

Equipped with

Flat-Bottom Plate Adaptor

PN: 186010495

+ 186010425

# Corning® 384-Well Clear Round Bottom Microplate

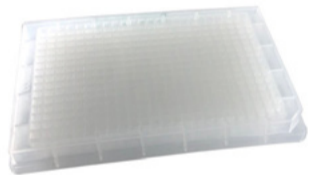

**Manufacturer:**  
Corning Inc.

**Part number:**  
3656



1-channel pipettes					
10 $\mu$ L	120 $\mu$ L	300 $\mu$ L	1000 $\mu$ L	5mL	10mL
✓	✓	✓	✓	✗	✗

8-channel pipettes			
10 $\mu$ L	120 $\mu$ L	300 $\mu$ L	1200 $\mu$ L
✓	✓	✓	✓



**HEATER-SHAKER+**  
Equipped with  
Flat-Bottom Plate Adaptor  
PN: 186010495  
+ 186010425

# Greiner, 96-well PS F-bottom clear microplate



**Manufacturer:**  
Greiner Bio-One

**Part number:**  
655101



1-channel pipettes					
10 $\mu$ L	120 $\mu$ L	300 $\mu$ L	1000 $\mu$ L	5mL	10mL
✓	✓	✓	✓	✗	✗

8-channel pipettes			
10 $\mu$ L	120 $\mu$ L	300 $\mu$ L	1200 $\mu$ L
✓	✓	✓	✓



**HEATER-SHAKER+**  
Equipped with  
Flat-Bottom Plate Adaptor  
PN: 186010495  
+ 186010425



# High Binding 96-Stripwell™ Flat Bottom Microplate

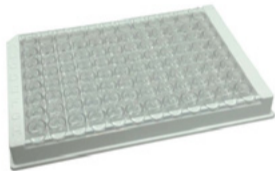

**Manufacturer:**

Corning Inc.

**Part number:**

7642

1-channel pipettes					
10 $\mu$ L	120 $\mu$ L	300 $\mu$ L	1000 $\mu$ L	5mL	10mL
✓	✓	✓	✓	✓	⊘

8-channel pipettes			
10 $\mu$ L	120 $\mu$ L	300 $\mu$ L	1200 $\mu$ L
✓	✓	✓	✓



**HEATER-SHAKER+**

Equipped with

Flat-Bottom Plate Adaptor

PN: 186010495

+ 186010425

# ibidi, 96-well ibiTreat black $\mu$ -Plate w/ polymer coverslip bottom



**Manufacturer:**  
ibidi

**Part number:**  
89626

1-channel pipettes					
10 $\mu$ L	120 $\mu$ L	300 $\mu$ L	1000 $\mu$ L	5mL	10mL
✓	✓	✓	✓	✓	✓

8-channel pipettes			
10 $\mu$ L	120 $\mu$ L	300 $\mu$ L	1200 $\mu$ L
✓	✓	✓	✓



**HEATER-SHAKER+**  
Equipped with  
Flat-Bottom Plate Adaptor  
PN: 186010495  
+ 186010425

# Pierce™ 96-Well Polystyrene Plates with Corner Notch



**Manufacturer:**  
Thermo Scientific

**Part number:**  
15041

## 1-channel pipettes

10 $\mu$ L	120 $\mu$ L	300 $\mu$ L	1000 $\mu$ L	5mL	10mL
✓	✓	✓	✓	✓	✗

## 8-channel pipettes

10 $\mu$ L	120 $\mu$ L	300 $\mu$ L	1200 $\mu$ L
✓	✓	✓	✓



**HEATER-SHAKER+**  
Equipped with  
Flat-Bottom Plate Adaptor  
PN: 186010495  
+ 186010425

# TPP 12-well tissue culture test plate



**Manufacturer:**  
TPP AG

**Part number:**  
92412

1-channel pipettes					
10 $\mu$ L	120 $\mu$ L	300 $\mu$ L	1000 $\mu$ L	5mL	10mL
✓	✓	✓	✓	✓	✓

8-channel pipettes			
10 $\mu$ L	120 $\mu$ L	300 $\mu$ L	1200 $\mu$ L
✗	✗	✗	✗



**HEATER-SHAKER+**

Equipped with

Flat-Bottom Plate Adaptor

PN: 186010495

+ 186010425

Ordering product number

**186010496**

OneLab reference: [518.4200]

# HEATER-SHAKER+ W/ SOLID-BASE PLATE ADAPTER

EQUIPPED WITH SOLID-BASE PLATE ADAPTOR

96X



Ordering product number

**186010492**

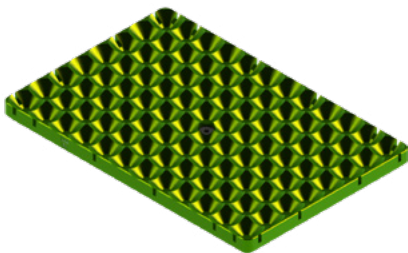

Solid-Base Plate Adaptor,  
Engraved Marking Code #E  
OneLab reference: [518.3311]



**E-SHOP AVAILABILITY  
COMING SOON**

# Agilent 96-well plate, 2.2 mL



**Manufacturer:**  
Agilent Technologies

**Part number:**  
5043-9300



1-channel pipettes					
10 $\mu$ L	120 $\mu$ L	300 $\mu$ L	1000 $\mu$ L	5mL	10mL
✓	✓	✓	✓	<b>300</b>	<b>750</b>

8-channel pipettes			
10 $\mu$ L	120 $\mu$ L	300 $\mu$ L	1200 $\mu$ L
<b>300</b>	✓	✓	✓



**HEATER-SHAKER+**  
Equipped with  
Solid-Base Plate Adaptor  
PN: 186010496  
+ 186010492

# Eppendorf 2 mL 96-square deep well plate, yellow frame



## Manufacturer:

Eppendorf

## Part number:

0030501314



## 1-channel pipettes

10 $\mu$ L	120 $\mu$ L	300 $\mu$ L	1000 $\mu$ L	5mL	10mL
✓	✓	✓	✓	<b>700</b>	<b>1 300</b>

## 8-channel pipettes

10 $\mu$ L	120 $\mu$ L	300 $\mu$ L	1200 $\mu$ L
<b>500</b>	✓	✓	✓



**HEATER-SHAKER+**  
Equipped with  
Solid-Base Plate Adaptor  
PN: 186010496  
+ 186010492

# Matrix™ 0.75 mL blank storage tube in 96x rack



**Manufacturer:**  
Thermo Scientific

**Part number:**  
4272

1-channel pipettes					
10µL	120µL	300µL	1000µL	5mL	10mL
✓	✓	✓	300	⚠	⚠

8-channel pipettes			
10µL	120µL	300µL	1200µL
200	✓	✓	✓



**HEATER-SHAKER+**  
Equipped with  
Solid-Base Plate Adaptor  
PN: 186010496  
+ 186010492



Ordering product number

**186010494**

OneLab reference: [518.4200]

# HEATER-SHAKER+ W/ CRYOVIAL ADAPTER

EQUIPPED WITH CRYOVIALS ADAPTOR



Ordering product number

**186010491**

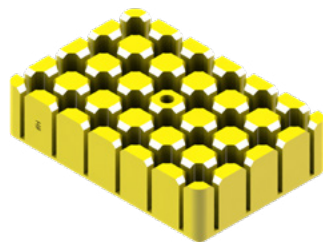

Cryovials Adaptor,  
Engraved Marking Code #E  
OneLab reference: [518.3411]



**E-SHOP AVAILABILITY  
COMING SOON**

# 2mL cryovial with Inner Thread, in 24 position rack



**Manufacturer:**  
Biozym

**Part number:**  
710522

1-channel pipettes					
10µL	120µL	300µL	1000µL	5mL	10mL
✓	✓	✓	✓	✓	✓

8-channel pipettes			
10µL	120µL	300µL	1200µL
✗	✗	✗	✗

## IMPORTANT

The Heater-Shaker+ Device with Cryovials Adaptor requires the use of the Cryovial Collection Rack (186011194) for these vials to be compatible. The Cryovial Collection Rack can be purchased individually or as part of the bundle 176XXXXX



Ordering product number  
**186011194**



CryoVial Collection Rack



Compatible with  
Microplate  
Gripper



**HEATER-SHAKER+**  
Equipped with  
Cryovials Adaptor  
PN: 186010494  
+ 186010491

Ordering product number  
**176005201/-202**  
OneLab reference: [518.7000]

## EXTRACTION+

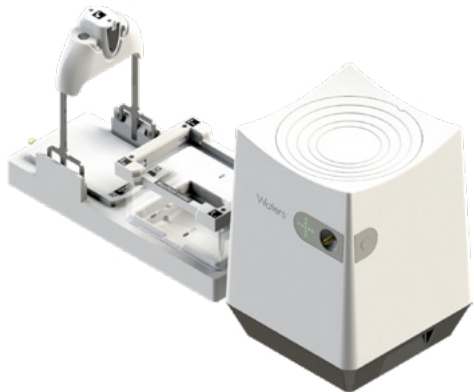

The Extraction+ system comprises the manifold with the collar lifter and the connected vacuum pump.

### EXTRACTION+ SYSTEM W/ MICROPLATE GRIPPER

[SEE THIS DEVICE  
ON OUR E-SHOP](#)

Ordering part number : 176005201

### EXTRACTION+ SYSTEM W/O MICROPLATE GRIPPER

[SEE THIS DEVICE  
ON OUR E-SHOP](#)

Ordering part number : 176005202

### DIRECT COMPATIBILITY

No adaptors are required for the following Extraction labware to be compatible with the Extraction+ Device

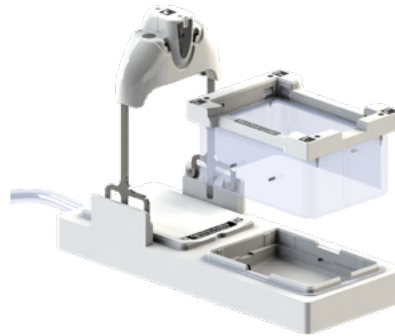

### IMPORTANT

Multiple different formats of consumables are compatible with the Extraction+ Device. Look out for the following format symbols and ensure that they match between your extraction and collection labware before making a selection. The 1x format is compatible with all extraction labware formats, but only for waste collection and not as a sample collection option.



# AcroPrep™ 7 mL 24-well Cell Clarification and Sterile Filtration plate



**Manufacturer:**  
Pall Corporation

**Part number:**  
97016

● ● ● ● ● ●  
**24X**  
● ● ● ● ● ●

## 1-channel pipettes

10 $\mu$ L	120 $\mu$ L	300 $\mu$ L	1000 $\mu$ L	5mL	10mL
✓	✓	✓	✓	✓	✓

## 8-channel pipettes

10 $\mu$ L	120 $\mu$ L	300 $\mu$ L	1200 $\mu$ L
✗	✗	✗	✗



**EXTRACTION +  
EXTRACTION LABWARE**  
Direct Compatibility  
PN: 176005201/-202

# Acroprep Advance 96-well Filter 2mL Plate



**Manufacturer:**  
Pall Corporation

**Part number:**  
8231

24X

1-channel pipettes					
10 $\mu$ L	120 $\mu$ L	300 $\mu$ L	1000 $\mu$ L	5mL	10mL
✓	✓	✓	✓	<b>600</b>	<b>1 000</b>

8-channel pipettes			
10 $\mu$ L	120 $\mu$ L	300 $\mu$ L	1200 $\mu$ L
<b>700</b>	✓	✓	✓



**EXTRACTION +  
EXTRACTION LABWARE**  
Direct Compatibility  
PN: 176005201/-202

# AcroPrep™ Advance 1 mL 96-well filter plate, 30K Omega membrane



**Manufacturer:**  
Pall Corporation

**Part number:**  
8165



1-channel pipettes					
10µL	120µL	300µL	1000µL	5mL	10mL
✓	✓	✓	✓	✓	✓

8-channel pipettes			
10µL	120µL	300µL	1200µL
✓	✓	✓	✓



**EXTRACTION +  
EXTRACTION LABWARE**  
Direct Compatibility  
PN: 176005201/-202

# AcroPrep™ Advance 350 $\mu$ L 96-well filter plate, 10K Omega membrane



**Manufacturer:**  
Pall Corporation

**Part number:**  
8034

96X

## 1-channel pipettes

10 $\mu$ L	120 $\mu$ L	300 $\mu$ L	1000 $\mu$ L	5mL	10mL
✓	✓	✓	✓	✓	✓

## 8-channel pipettes

10 $\mu$ L	120 $\mu$ L	300 $\mu$ L	1200 $\mu$ L
✓	✓	✓	✓



**EXTRACTION +  
EXTRACTION LABWARE**  
Direct Compatibility  
PN: 176005201/-202



# Advantage™ 2 mL 96-well diatomaceous earth filter plate



**Manufacturer:**  
Analytical Sales  
& Services, Inc.

**Part number:**  
96260-1



1-channel pipettes					
10µL	120µL	300µL	1000µL	5mL	10mL
✓	✓	✓	✓	✓	✓

8-channel pipettes			
10µL	120µL	300µL	1200µL
✓	✓	✓	✓



**EXTRACTION +  
EXTRACTION LABWARE**  
Direct Compatibility  
PN: 176005201/-202

# ArcticWhite, 400 $\mu$ L 96-well filter plate, hydrophilic PVDF, 0.45 $\mu$ m



**Manufacturer:**  
ArcticWhite LLC

**Part number:**  
AWFP-F20011

96X

1-channel pipettes					
10 $\mu$ L	120 $\mu$ L	300 $\mu$ L	1000 $\mu$ L	5mL	10mL
✓	✓	✓	✓	⚠	⚠

8-channel pipettes			
10 $\mu$ L	120 $\mu$ L	300 $\mu$ L	1200 $\mu$ L
✓	✓	✓	✓



**EXTRACTION +  
EXTRACTION LABWARE**  
Direct Compatibility  
PN: 1760052011-202

# Biotage ISOLUTE® SLE+ 200 µL 96-well SLE plate



**Manufacturer:**  
Biotage

**Part number:**  
820-0200-P01

**96X**

1-channel pipettes					
10µL	120µL	300µL	1000µL	5mL	10mL
✓	✓	✓	✓	✓	<b>700</b>

8-channel pipettes			
10µL	120µL	300µL	1200µL
✓	✓	✓	✓



**EXTRACTION +  
EXTRACTION LABWARE**  
Direct Compatibility  
PN: 176005201/-202

# Cytiva, PreDictor 96-well plate, 150 $\mu$ L MabSelect resin/well



**Manufacturer:**  
Cytiva

**Part number:**  
28985262



1-channel pipettes					
10 $\mu$ L	120 $\mu$ L	300 $\mu$ L	1000 $\mu$ L	5mL	10mL
✓	✓	✓	150	200	

8-channel pipettes			
10 $\mu$ L	120 $\mu$ L	300 $\mu$ L	1200 $\mu$ L
✓	✓	✓	✓



**EXTRACTION +  
EXTRACTION LABWARE**  
Direct Compatibility  
PN: 176005201/-202

# MACHEREY-NAGEL, NucleoSpin® 96 virus binding plate



**Manufacturer:**  
MACHEREY-NAGEL

**Part number:**  
740691.4S

96X

1-channel pipettes					
10µL	120µL	300µL	1000µL	5mL	10mL
✓	✓	✓	✓	✓	✗

8-channel pipettes			
10µL	120µL	300µL	1200µL
✓	✓	✓	✓



**EXTRACTION +  
EXTRACTION LABWARE**  
Direct Compatibility  
PN: 176005201/-202

# MultiScreen® HTS HV clear 96-well filter plate, 0.45 µm pore size



**Manufacturer:**  
Merck

**Part number:**  
MSHVS4510

96X

1-channel pipettes					
10µL	120µL	300µL	1000µL	5mL	10mL
✓	✓	✓	✓	⚠	⚠

8-channel pipettes			
10µL	120µL	300µL	1200µL
✓	✓	✓	✓

**EXTRACTION +  
EXTRACTION LABWARE**  
Direct Compatibility  
PN: 176005201/-202

# MultiScreen® Solvinert™ 96-well filter plate, 0.45 µm pore size



**Manufacturer:**  
Merck

**Part number:**  
MSRLN0450

96X

1-channel pipettes					
10µL	120µL	300µL	1000µL	5mL	10mL
✓	✓	✓	✓	⚠	⚠

8-channel pipettes			
10µL	120µL	300µL	1200µL
✓	✓	✓	✓



**EXTRACTION +  
EXTRACTION LABWARE**  
Direct Compatibility  
PN: 176005201/-202

# Oasis HLB 96-square well plate, 30 mg sorbent/well



SEE THIS CONSUMABLE  
ON OUR E-SHOP

**Manufacturer:**  
Waters Corporation

**Part number:**  
WAT058951

96X

1-channel pipettes					
10 $\mu$ L	120 $\mu$ L	300 $\mu$ L	1000 $\mu$ L	5mL	10mL
✓	✓	✓	✓	⚠	⚠

8-channel pipettes			
10 $\mu$ L	120 $\mu$ L	300 $\mu$ L	1200 $\mu$ L
✓	✓	✓	✓



**EXTRACTION +  
EXTRACTION LABWARE**  
Direct Compatibility  
PN: 176005201/-202



# Oasis HLB 96-square well plate, 60 mg sorbent/well



SEE THIS CONSUMABLE  
ON OUR E-SHOP

**Manufacturer:**  
Waters

**Part number:**  
186000679

96X

1-channel pipettes					
10 $\mu$ L	120 $\mu$ L	300 $\mu$ L	1000 $\mu$ L	5mL	10mL
✓	✓	✓	✓	⚠	⚠

8-channel pipettes			
10 $\mu$ L	120 $\mu$ L	300 $\mu$ L	1200 $\mu$ L
✓	✓	✓	✓



EXTRACTION +  
EXTRACTION LABWARE  
Direct Compatibility  
PN: 176005201/-202

# Oasis HLB 96-well $\mu$ Elution plate, 2 mg sorbent/well



SEE THIS CONSUMABLE  
ON OUR E-SHOP

**Manufacturer:**  
Waters

**Part number:**  
186001828BA

96X

1-channel pipettes					
10 $\mu$ L	120 $\mu$ L	300 $\mu$ L	1000 $\mu$ L	5mL	10mL
✓	✓	✓	✓	⚠	⚠

8-channel pipettes			
10 $\mu$ L	120 $\mu$ L	300 $\mu$ L	1200 $\mu$ L
✓	✓	✓	✓



EXTRACTION +  
EXTRACTION LABWARE  
Direct Compatibility  
PN: 176005201/-202

# Oasis method development 96-well $\mu$ Elution plate, 2 mg sorbent/well



SEE THIS CONSUMABLE  
ON OUR E-SHOP

**Manufacturer:**  
Waters

**Part number:**  
186004475

96X

1-channel pipettes					
10 $\mu$ L	120 $\mu$ L	300 $\mu$ L	1000 $\mu$ L	5mL	10mL
✓	✓	✓	✓	✓	⚠

8-channel pipettes			
10 $\mu$ L	120 $\mu$ L	300 $\mu$ L	1200 $\mu$ L
✓	✓	✓	✓



EXTRACTION +  
EXTRACTION LABWARE  
Direct Compatibility  
PN: 176005201/-202

# Oasis peptide method development 96-well $\mu$ Elution plate, 2 mg sorbent/well



SEE THIS CONSUMABLE  
ON OUR E-SHOP

**Manufacturer:**  
Waters Corporation

**Part number:**  
186004713

96X

1-channel pipettes					
10 $\mu$ L	120 $\mu$ L	300 $\mu$ L	1000 $\mu$ L	5mL	10mL
✓	✓	✓	✓	150	200

8-channel pipettes			
10 $\mu$ L	120 $\mu$ L	300 $\mu$ L	1200 $\mu$ L
✓	✓	✓	✓



EXTRACTION +  
EXTRACTION LABWARE  
Direct Compatibility  
PN: 176005201/-202

# Oasis PRiME HLB 96-well plate, 10 mg sorbent/well



SEE THIS CONSUMABLE  
ON OUR E-SHOP

**Manufacturer:**  
Waters Corporation

**Part number:**  
186008053

96X

1-channel pipettes					
10 $\mu$ L	120 $\mu$ L	300 $\mu$ L	1000 $\mu$ L	5mL	10mL
✓	✓	✓	✓	⚠	⚠

8-channel pipettes			
10 $\mu$ L	120 $\mu$ L	300 $\mu$ L	1200 $\mu$ L
✓	✓	✓	✓



EXTRACTION +  
EXTRACTION LABWARE  
Direct Compatibility  
PN: 176005201/-202

# Oasis PRiME HLB 96-well plate, 30 mg sorbent/well



SEE THIS CONSUMABLE  
ON OUR E-SHOP

**Manufacturer:**  
Waters Corporation

**Part number:**  
186008054

96X

1-channel pipettes					
10 $\mu$ L	120 $\mu$ L	300 $\mu$ L	1000 $\mu$ L	5mL	10mL
✓	✓	✓	✓	✓	⚠

8-channel pipettes			
10 $\mu$ L	120 $\mu$ L	300 $\mu$ L	1200 $\mu$ L
✓	✓	✓	✓



EXTRACTION +  
EXTRACTION LABWARE  
Direct Compatibility  
PN: 176005201/-202

# Oasis PRiME HLB 96-well $\mu$ Elution plate, 3 mg sorbent/well



SEE THIS CONSUMABLE  
ON OUR E-SHOP

**Manufacturer:**  
Waters

**Part number:**  
186008052

96X

1-channel pipettes					
10 $\mu$ L	120 $\mu$ L	300 $\mu$ L	1000 $\mu$ L	5mL	10mL
✓	✓	✓	✓	✓	⚠

8-channel pipettes			
10 $\mu$ L	120 $\mu$ L	300 $\mu$ L	1200 $\mu$ L
✓	✓	✓	✓



**EXTRACTION +  
EXTRACTION LABWARE**  
Direct Compatibility  
PN: 176005201/-202

# Oasis PRiME MCX 96-well $\mu$ Elution plate, 2 mg sorbent/well



SEE THIS CONSUMABLE  
ON OUR E-SHOP

**Manufacturer:**  
Waters

**Part number:**  
186008914

96X

1-channel pipettes					
10 $\mu$ L	120 $\mu$ L	300 $\mu$ L	1000 $\mu$ L	5mL	10mL
✓	✓	✓	✓	✓	⚠

8-channel pipettes			
10 $\mu$ L	120 $\mu$ L	300 $\mu$ L	1200 $\mu$ L
✓	✓	✓	✓



EXTRACTION +  
EXTRACTION LABWARE  
Direct Compatibility  
PN: 176005201/-202



# Ostro protein precipitation & phospholipid removal 96-well plate



SEE THIS CONSUMABLE  
ON OUR E-SHOP

**Manufacturer:**  
Waters

**Part number:**  
186005518

96X

1-channel pipettes					
10 $\mu$ L	120 $\mu$ L	300 $\mu$ L	1000 $\mu$ L	5mL	10mL
✓	✓	✓	✓	⚠	⚠

8-channel pipettes			
10 $\mu$ L	120 $\mu$ L	300 $\mu$ L	1200 $\mu$ L
✓	✓	✓	✓



EXTRACTION +  
EXTRACTION LABWARE  
Direct Compatibility  
PN: 176005201/-202

# PreDictor MabSelect SuRe, 50 $\mu$ L 96-Well Plate



**Manufacturer:**  
Cytiva

**Part number:**  
28925825



1-channel pipettes					
10 $\mu$ L	120 $\mu$ L	300 $\mu$ L	1000 $\mu$ L	5mL	10mL
✓	✓	✓	300	300	

8-channel pipettes			
10 $\mu$ L	120 $\mu$ L	300 $\mu$ L	1200 $\mu$ L
✓	✓	✓	✓



**EXTRACTION +  
EXTRACTION LABWARE**  
Direct Compatibility  
PN: 176005201/-202

# Thermo Scientific™ HyperSep™ 96-well PPT plate



**Manufacturer:**  
Thermo Scientific

**Part number:**  
60304-201



1-channel pipettes					
10 $\mu$ L	120 $\mu$ L	300 $\mu$ L	1000 $\mu$ L	5mL	10mL
✓	✓	✓	✓	✓	✓

8-channel pipettes			
10 $\mu$ L	120 $\mu$ L	300 $\mu$ L	1200 $\mu$ L
✓	✓	✓	✓



**EXTRACTION +  
EXTRACTION LABWARE**  
Direct Compatibility  
PN: 176005201/-202

# Waters GlycoWorks™ HILIC $\mu$ Elution plate



SEE THIS CONSUMABLE  
ON OUR E-SHOP

**Manufacturer:**  
Waters

**Part number:**  
186002780

96X

1-channel pipettes					
10 $\mu$ L	120 $\mu$ L	300 $\mu$ L	1000 $\mu$ L	5mL	10mL
✓	✓	✓	✓	✓	⚠

8-channel pipettes			
10 $\mu$ L	120 $\mu$ L	300 $\mu$ L	1200 $\mu$ L
✓	✓	✓	✓



EXTRACTION +  
EXTRACTION LABWARE  
Direct Compatibility  
PN: 176005201/-202

# Waters Sirocco™ 96-well protein precipitation plate



SEE THIS CONSUMABLE  
ON OUR E-SHOP

**Manufacturer:**  
Waters

**Part number:**  
186003873

96X

## 1-channel pipettes

10µL	120µL	300µL	1000µL	5mL	10mL
✓	✓	✓	✓	✓	<b>500</b>

## 8-channel pipettes

10µL	120µL	300µL	1200µL
✓	✓	✓	✓



**EXTRACTION +  
EXTRACTION LABWARE**  
Direct Compatibility  
PN: 176005201/-202

# Zeba™ Spin Desalting Plate



**Manufacturer:**  
Thermo Scientific

**Part number:**  
A57768

**96X**

## 1-channel pipettes

10µL	120µL	300µL	1000µL	5mL	10mL
✓	✓	✓	<b>200</b>	<b>100</b>	<b>300</b>

## 8-channel pipettes

10µL	120µL	300µL	1200µL
<b>150</b>	✓	✓	✓



**EXTRACTION +  
EXTRACTION LABWARE**  
Direct Compatibility  
PN: 176005201/-202

### COMPATIBILITY VIA 1CC CARTRIDGE ADAPTOR



The 1cc Cartridge Adaptor is required for the following extraction labware to be compatible with Extraction+

### IMPORTANT

The 1cc Cartridge Adaptor can be purchased individually or as part of the Extraction+ 1cc Cartridge Kit for seamless compatibility and full automation with your preferred collection labware.

**SEE THIS KIT  
ON OUR E-SHOP**



Pack of 24x 1cc Sealing Caps  
186010535

1cc Cartridge Adaptor  
186010528

Ø12mm vial Collection Rack  
186010531

Collection Labware Rack Domino  
186010523

Extraction+ 1cc Cartridge Kit  
**176005204**

# Oasis HLB 1 cc Vac cartridge, 10 mg sorbent, 30 $\mu$ m, racked



SEE THIS CONSUMABLE  
ON OUR E-SHOP

**Manufacturer:**  
Waters Corporation

**Part number:**  
186000383

24X

## 1-channel pipettes

10 $\mu$ L	120 $\mu$ L	300 $\mu$ L	1000 $\mu$ L	5mL	10mL
<b>700</b>	<b>400</b>	<b>400</b>			

## 8-channel pipettes

10 $\mu$ L	120 $\mu$ L	300 $\mu$ L	1200 $\mu$ L



+



**EXTRACTION LABWARE**  
Compatibility via  
1cc Cartridge Adaptor  
PN: 176005201/-202  
+ 186010528



# Oasis HLB 1 cc Vac cartridge, 30 mg sorbent, 30 $\mu$ m, racked



SEE THIS CONSUMABLE  
ON OUR E-SHOP

**Manufacturer:**  
Waters Corporation

**Part number:**  
WAT094225

24X

## 1-channel pipettes

10 $\mu$ L	120 $\mu$ L	300 $\mu$ L	1000 $\mu$ L	5mL	10mL
700	400	400			

## 8-channel pipettes

10 $\mu$ L	120 $\mu$ L	300 $\mu$ L	1200 $\mu$ L



+



**EXTRACTION LABWARE**  
Compatibility via  
1cc Cartridge Adaptor  
PN: 176005201/-202  
+ 186010528

# Oasis PRiME MCX 1 cc Vac cartridge, 30 mg sorbent, 30 $\mu$ m, racked



**Manufacturer:**  
Waters Corporation

**Part number:**  
186008917

SEE THIS CONSUMABLE  
ON OUR E-SHOP

24X

1-channel pipettes					
10 $\mu$ L	120 $\mu$ L	300 $\mu$ L	1000 $\mu$ L	5mL	10mL
700	400	400			

8-channel pipettes			
10 $\mu$ L	120 $\mu$ L	300 $\mu$ L	1200 $\mu$ L



**EXTRACTION LABWARE**  
Compatibility via  
1cc Cartridge Adaptor  
PN: 176005201/-202  
+ 186010528

# Sep-Pak SEC 1cc desalting cartridge, 5k MWCO, racked



SEE THIS CONSUMABLE  
ON OUR E-SHOP

**Manufacturer:**  
Waters Corporation

**Part number:**  
186010127

24X

## 1-channel pipettes

10 $\mu$ L	120 $\mu$ L	300 $\mu$ L	1000 $\mu$ L	5mL	10mL
✓	✓	✓	✓	⚠	⚠

## 8-channel pipettes

10 $\mu$ L	120 $\mu$ L	300 $\mu$ L	1200 $\mu$ L
✗	✗	✗	✗



+



**EXTRACTION LABWARE**  
Compatibility via  
1cc Cartridge Adaptor  
PN: 176005201/-202  
+ 186010528

### COMPATIBILITY VIA 3CC CARTRIDGE ADAPTOR



The 3cc Cartridge Adaptor is required for the following extraction labware to be compatible with Extraction+

### IMPORTANT

The 3cc Cartridge Adaptor can be purchased individually or as part of the Extraction+ 3cc Cartridge Kit for seamless compatibility and full automation with your preferred collection labware.

**SEE THIS KIT  
ON OUR E-SHOP**

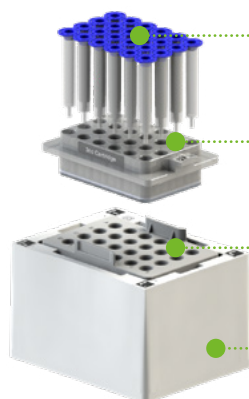

Pack of 24x 3cc Sealing Caps  
186010536

3cc Cartridge Adaptor  
186010529

Ø12mm vial Collection Rack  
186010531

Collection Labware Rack Domino  
186010523

Extraction+ 3cc Cartridge Kit  
**176005205**

# Oasis HLB 3 cc Vac cartridge, 60 mg sorbent, 30 $\mu$ m, racked



SEE THIS CONSUMABLE  
ON OUR E-SHOP

**Manufacturer:**  
Waters Corporation

**Part number:**  
WAT094226

24X

## 1-channel pipettes

10 $\mu$ L	120 $\mu$ L	300 $\mu$ L	1000 $\mu$ L	5mL	10mL
✓	✓	✓	✓	2 000	2 800

## 8-channel pipettes

10 $\mu$ L	120 $\mu$ L	300 $\mu$ L	1200 $\mu$ L
✗	✗	✗	✗



+



**EXTRACTION LABWARE**  
Compatibility via  
3cc Cartridge Adaptor  
PN: 176005201/-202  
+ 186010529

# Oasis HLB 3 cc flangeless Vac cartridge, 60 mg sorbent, 30 $\mu$ m, racked



SEE THIS CONSUMABLE  
ON OUR E-SHOP

**Manufacturer:**  
Waters Corporation

**Part number:**  
186001880

24X

## 1-channel pipettes

10 $\mu$ L	120 $\mu$ L	300 $\mu$ L	1000 $\mu$ L	5mL	10mL
✓	✓	✓	✓	<b>2 000</b>	<b>2 800</b>

## 8-channel pipettes

10 $\mu$ L	120 $\mu$ L	300 $\mu$ L	1200 $\mu$ L
✗	✗	✗	✗



+



**EXTRACTION LABWARE**  
Compatibility via  
3cc Cartridge Adaptor  
PN: 176005201/-202  
+ 186010529

### COMPATIBILITY VIA 6CC CARTRIDGE ADAPTOR



The 3cc Cartridge Adaptor is required for the following extraction labware to be compatible with Extraction+

### IMPORTANT

The 6cc Cartridge Adaptor can be purchased individually or as part of the Extraction+ 6cc Cartridge Kit for seamless compatibility and full automation with your preferred collection labware.

**SEE THIS KIT  
ON OUR E-SHOP**



Pack of 24x 6cc Sealing Caps  
186010537

6cc Cartridge Adaptor  
186010530

5mL Tube Collection Rack  
186010534

Collection Labware Rack Domino  
186010523

Extraction+ 6cc Cartridge Kit  
**176005206**

# Cytiva, Amersham NAP-10 DNA purification column, racked



**Manufacturer:**

Cytiva

**Part number:**

17085401



1-channel pipettes					
10 $\mu$ L	120 $\mu$ L	300 $\mu$ L	1000 $\mu$ L	5mL	10mL
✓	✓	✓	✓	✓	✓

8-channel pipettes			
10 $\mu$ L	120 $\mu$ L	300 $\mu$ L	1200 $\mu$ L
✗	✗	✗	✗



**EXTRACTION LABWARE**  
Compatibility via  
6cc Cartridge Adaptor  
PN: 176005201/-202  
+ 186010530



# Oasis HLB 6 cc Vac cartridge, 150 mg sorbent, 30 $\mu\text{m}$ , racked



SEE THIS CONSUMABLE  
ON OUR E-SHOP

**Manufacturer:**  
Waters Corporation

**Part number:**  
186003365

12X

## 1-channel pipettes

10 $\mu\text{L}$	120 $\mu\text{L}$	300 $\mu\text{L}$	1000 $\mu\text{L}$	5mL	10mL
✓	✓	✓	✓	✓	✓

## 8-channel pipettes

10 $\mu\text{L}$	120 $\mu\text{L}$	300 $\mu\text{L}$	1200 $\mu\text{L}$
✗	✗	✗	✗



+



**EXTRACTION LABWARE**  
Compatibility via  
6cc Cartridge Adaptor  
PN: 176005201/-202  
+ 186010530

# Oasis HLB 6 cc Vac cartridge, 200 mg sorbent, 30 $\mu\text{m}$ , racked



SEE THIS CONSUMABLE  
ON OUR E-SHOP

**Manufacturer:**  
Waters Corporation

**Part number:**  
WAT106202

12X

## 1-channel pipettes

10 $\mu\text{L}$	120 $\mu\text{L}$	300 $\mu\text{L}$	1000 $\mu\text{L}$	5mL	10mL
✓	✓	✓	✓	✓	✓

## 8-channel pipettes

10 $\mu\text{L}$	120 $\mu\text{L}$	300 $\mu\text{L}$	1200 $\mu\text{L}$
✗	✗	✗	✗



+



**EXTRACTION LABWARE**  
Compatibility via  
6cc Cartridge Adaptor  
PN: 176005201/-202  
+ 186010530

# EXTRACTION+

## EXTRACTION LABWARE

### COMPATIBILITY VIA 8-POSITION, 6CC CARTRIDGE ADAPTOR

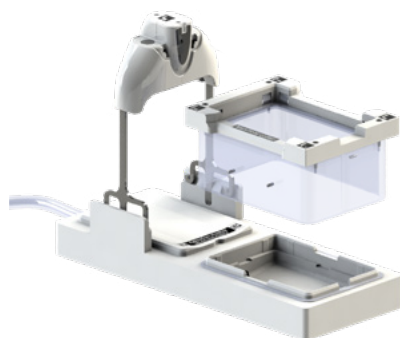

Ordering product number  
**18601117**



8X

8-position 6CC Cartridge Adaptor

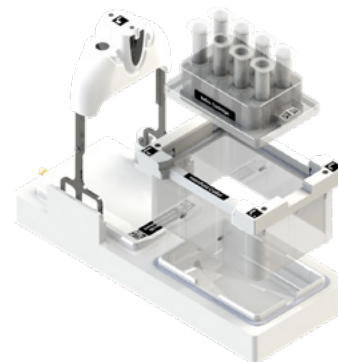

The 8-position, 6cc Cartridge Adaptor is required for the following extraction labware to be compatible with Extraction+

### IMPORTANT

The 8-position 6cc Cartridge Adaptor can be purchased individually or as part of the Extraction+ 8-position 6cc Cartridge kit for seamless compatibility and full automation with your preferred collection labware.

**E-SHOP AVAILABILITY  
COMING SOON**

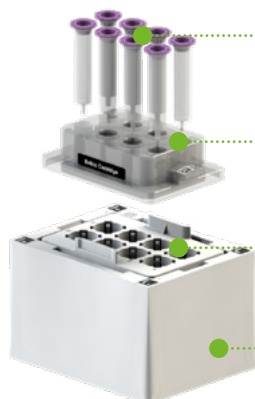

Pack of 6cc Sealing Caps  
186010537

8-position 6cc Cartridge Adaptor  
186011117

10mL Vial Collection Rack  
186111118

Collection Labware Rack Domino  
186010523

Extraction+ 6cc  
8-position Cartridge Kit  
**176005433**

# Cytiva, Amersham NAP-10 DNA purification column, in 8 positions rack



**Manufacturer:**

Cytiva

**Part number:**

17085401



1-channel pipettes					
10 $\mu$ L	120 $\mu$ L	300 $\mu$ L	1000 $\mu$ L	5mL	10mL
✓	✓	✓	✓	✓	✓

8-channel pipettes			
10 $\mu$ L	120 $\mu$ L	300 $\mu$ L	1200 $\mu$ L
✗	✗	✗	✗



**EXTRACTION LABWARE**

Compatibility via 8-position,

6cc Cartridge Adaptor

PN: 176005201/-202

+ 186011117

# Oasis HLB 6 cc Vac cartridge, 150 mg sorbent, 30 $\mu$ m, in 8 positions rack



SEE THIS CONSUMABLE  
ON OUR E-SHOP

**Manufacturer:**  
Waters Corporation

**Part number:**  
186003365



1-channel pipettes					
10 $\mu$ L	120 $\mu$ L	300 $\mu$ L	1000 $\mu$ L	5mL	10mL
✓	✓	✓	✓	✓	✓

8-channel pipettes			
10 $\mu$ L	120 $\mu$ L	300 $\mu$ L	1200 $\mu$ L
✗	✗	✗	✗



**EXTRACTION LABWARE**  
Compatibility via 8-position,  
6cc Cartridge Adaptor  
PN: 176005201/-202  
+ 186011117

# Oasis HLB 6 cc Vac cartridge, 200 mg sorbent, 30 $\mu$ m, in 8 positions rack



**Manufacturer:**  
Waters Corporation

**Part number:**  
WAT106202

SEE THIS CONSUMABLE  
ON OUR E-SHOP



1-channel pipettes					
10 $\mu$ L	120 $\mu$ L	300 $\mu$ L	1000 $\mu$ L	5mL	10mL
✓	✓	✓	✓	✓	✓

8-channel pipettes			
10 $\mu$ L	120 $\mu$ L	300 $\mu$ L	1200 $\mu$ L
✗	✗	✗	✗



**EXTRACTION LABWARE**  
Compatibility via 8-position,  
6cc Cartridge Adaptor  
PN: 176005201/-202  
+ 186011117

### DIRECT COMPATIBILITY

No adaptors are required for the following Waste and Collection labware to be compatible with the Extraction+ Device itself. Depending on the workflow requirements, they can either be directly placed inside the manifold at the start of a run or on a compatible Domino within the Andrew+ workbench.

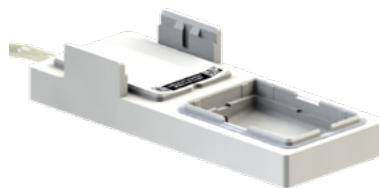

### IMPORTANT

For fully automated Extraction+ workflows involving waste and collection labware movements, ensure that you are equipped with both the Andrew+ Microplate Gripper Tool and a Domino compatible with the desired waste and/or collection labware on the Andrew+ workbench.

Gripper compatibility is confirmed with the following symbol :



We'll let you know which Domino(s) you'll need to enable fully automated extraction workflows with the consumable(s) of your choice :



For seamless compatibility and full automation with your preferred waste and/or collection labware in plate formats, we highly recommend acquiring the Extraction+ Plate Kit

[SEE THIS DEVICE ON OUR E-SHOP](#)

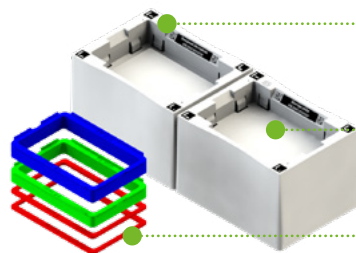

Deepwell Microplate Domino  
186009597

Storage Plate Domino  
186009596

Collection Plate Spacer Kit  
186010527

Extraction+ Plate Kit  
**176005203**

**EXTRACTION+**

WASTE & COLLECTION LABWARE

DIRECT COMPATIBILITY - 96X PLATE FORMATS

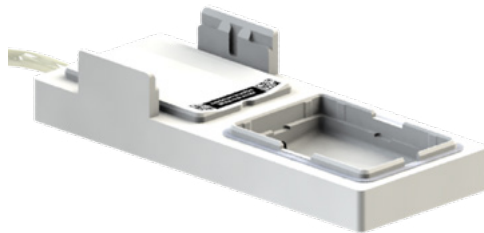

96X



# Nunc™ 1.3 mL 96-DeepWell™ plate



**Manufacturer:**  
Thermo Scientific

**Part number:**  
260251



## 1-channel pipettes

10µL	120µL	300µL	1000µL	5mL	10mL
✓	✓	✓	✓	✓	✓

## 8-channel pipettes

10µL	120µL	300µL	1200µL
✓	✓	✓	✓



**FULLY AUTOMATE WITH**  
Deepwell Microplate Domino  
186009597



**COLLECTION LABWARE**

Direct Compatibility - 96X Plate Formats  
PN: 176005201/-/202

# Riplate® Medio 1mL Deepwell Plate



## Manufacturer:

Carl Roth

## Part number:

TC22.1

0.9



Compatible with  
Microplate  
Gripper



1-channel pipettes					
10µL	120µL	300µL	1000µL	5mL	10mL
✓	✓	✓	✓	✓	✓

8-channel pipettes			
10µL	120µL	300µL	1200µL
450	✓	✓	✓



**FULLY AUTOMATE WITH**  
Deepwell Microplate Domino  
186009597



**COLLECTION LABWARE**

Direct Compatibility - 96X Plate Formats  
PN: 176005201/-202

# Riplate® 2mL Deepwell Plate



## Manufacturer:

Carl Roth

## Part number:

EN07.1

96



Compatible with  
Microplate  
Gripper



## 1-channel pipettes

10µL	120µL	300µL	1000µL	5mL	10mL
✓	✓	✓	✓	<b>800</b>	<b>1 200</b>

## 8-channel pipettes

10µL	120µL	300µL	1200µL
<b>600</b>	✓	✓	✓



**FULLY AUTOMATE WITH**  
Deepwell Microplate Domino  
186009597



**COLLECTION LABWARE**

Direct Compatibility - 96X Plate Formats  
PN: 176005201/-202

# Waters 2 mL 96-square well collection plate, cut corner A1/H1



## Manufacturer:

Waters

## Part number:

WAT058958

96



Compatible with  
Microplate  
Gripper

SEE THIS CONSUMABLE  
ON OUR E-SHOP



1-channel pipettes					
10 $\mu$ L	120 $\mu$ L	300 $\mu$ L	1000 $\mu$ L	5mL	10mL
✓	✓	✓	✓	<b>300</b>	<b>850</b>

8-channel pipettes			
10 $\mu$ L	120 $\mu$ L	300 $\mu$ L	1200 $\mu$ L
✓	✓	✓	✓



FULLY AUTOMATE WITH  
Deepwell Microplate Domino  
186009597

# Waters 2 mL 96-square well collection plate, cut corner H1



**Manufacturer:**  
Waters

**Part number:**  
186002482



SEE THIS CONSUMABLE  
ON OUR E-SHOP



## 1-channel pipettes

10 $\mu$ L	120 $\mu$ L	300 $\mu$ L	1000 $\mu$ L	5mL	10mL
✓	✓	✓	✓	<b>300</b>	<b>850</b>

## 8-channel pipettes

10 $\mu$ L	120 $\mu$ L	300 $\mu$ L	1200 $\mu$ L
✓	✓	✓	✓



**FULLY AUTOMATE WITH**  
Deepwell Microplate Domino  
186009597



**COLLECTION LABWARE**

Direct Compatibility - 96X Plate Formats  
PN: 176005201/-202

# Waters 350 $\mu$ L 96-round well collection plate



**COLLECTION LABWARE**  
Direct Compatibility - 96X Plate Formats  
PN: 176005201/-202



**Manufacturer:**  
Waters Corporation

**Part number:**  
186002643



SEE THIS CONSUMABLE  
ON OUR E-SHOP



96X

## 1-channel pipettes

10 $\mu$ L	120 $\mu$ L	300 $\mu$ L	1000 $\mu$ L	5mL	10mL
✓	✓	✓	✓	✓	✓

## 8-channel pipettes

10 $\mu$ L	120 $\mu$ L	300 $\mu$ L	1200 $\mu$ L
✓	✓	✓	✓



**FULLY AUTOMATE WITH**  
Deepwell Microplate Domino  
186009597

# Waters 700 $\mu$ L 96-round well collection plate



**COLLECTION LABWARE**  
Direct Compatibility - 96X Plate Formats  
PN: 176005201/-202



**Manufacturer:**  
Waters

**Part number:**  
186005837



SEE THIS CONSUMABLE  
ON OUR E-SHOP



96X

## 1-channel pipettes

10 $\mu$ L	120 $\mu$ L	300 $\mu$ L	1000 $\mu$ L	5mL	10mL
✓	✓	✓	100	100	

## 8-channel pipettes

10 $\mu$ L	120 $\mu$ L	300 $\mu$ L	1200 $\mu$ L
200	✓	✓	✓



**FULLY AUTOMATE WITH**  
Deepwell Microplate Domino  
186009597

# Waters 800 $\mu$ L 96-round well collection plate



**COLLECTION LABWARE**  
Direct Compatibility - 96X Plate Formats  
PN: 176005201/-202



**Manufacturer:**  
Waters Corporation

**Part number:**  
186002481



SEE THIS CONSUMABLE  
ON OUR E-SHOP



1-channel pipettes					
10 $\mu$ L	120 $\mu$ L	300 $\mu$ L	1000 $\mu$ L	5mL	10mL
✓	✓	✓	50	200	400

8-channel pipettes			
10 $\mu$ L	120 $\mu$ L	300 $\mu$ L	1200 $\mu$ L
200	✓	✓	✓



**FULLY AUTOMATE WITH**  
Deepwell Microplate Domino  
186009597



# Waters GlycoWorks™ 600 µL tubes in 96x plate



**Manufacturer:**  
Waters

**Part number:**  
186007988-3



SEE THIS CONSUMABLE  
ON OUR E-SHOP



## 1-channel pipettes

10µL	120µL	300µL	1000µL	5mL	10mL
120	✓	✓	300	300	

## 8-channel pipettes

10µL	120µL	300µL	1200µL
120	✓	✓	300



FULLY AUTOMATE WITH  
Deepwell Microplate Domino  
186009597



COLLECTION LABWARE

Direct Compatibility - 96X Plate Formats  
PN: 176005201/-202

# Waters QuanRecovery™ 700 µL 96-well plate



**COLLECTION LABWARE**  
Direct Compatibility - 96X Plate Formats  
PN: 176005201/-202



**Manufacturer:**  
Waters

**Part number:**  
186009185



SEE THIS CONSUMABLE  
ON OUR E-SHOP



1-channel pipettes					
10µL	120µL	300µL	1000µL	5mL	10mL
✓	✓	✓	50	200	400

8-channel pipettes			
10µL	120µL	300µL	1200µL
200	✓	✓	✓



**FULLY AUTOMATE WITH**  
Deepwell Microplate Domino  
186009597

**EXTRACTION+**

WASTE & COLLECTION LABWARE

DIRECT COMPATIBILITY - 24X PLATE FORMATS

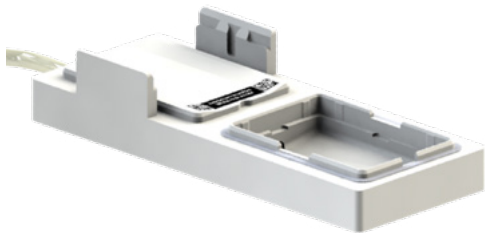

24X

# AcroPrep™ 24-well collection plate



**Manufacturer:**  
Pall Corporation

**Part number:**  
NA



## 1-channel pipettes

10 $\mu$ L	120 $\mu$ L	300 $\mu$ L	1000 $\mu$ L	5mL	10mL
✓	✓	✓	✓	✓	✓

## 8-channel pipettes

10 $\mu$ L	120 $\mu$ L	300 $\mu$ L	1200 $\mu$ L
✗	✗	✗	✗



**FULLY AUTOMATE WITH**  
Deepwell Microplate Domino  
186009597



**COLLECTION LABWARE**

Direct Compatibility - 24X Plate Formats  
PN: 176005201/-202

# Axygen® 10 mL 24-square deep well V-bottom plate



**Manufacturer:**

Corning Inc.

**Part number:**

P-DW-10ML-24-C-S



24X

### 1-channel pipettes

10µL	120µL	300µL	1000µL	5mL	10mL
✓	✓	✓	✓	✓	✓

### 8-channel pipettes

10µL	120µL	300µL	1200µL
✗	✗	✗	✗



**FULLY AUTOMATE WITH**  
Deepwell Microplate Domino  
186009597



**COLLECTION LABWARE**

Direct Compatibility - 24X Plate Formats  
PN: 176005201/-/202

# Sartorius, 24-deep well V-bottom plate



**Manufacturer:**  
Sartorius

**Part number:**  
A-0038



24X

## 1-channel pipettes

10 $\mu$ L	120 $\mu$ L	300 $\mu$ L	1000 $\mu$ L	5mL	10mL
✓	✓	✓	✓	✓	✓

## 8-channel pipettes

10 $\mu$ L	120 $\mu$ L	300 $\mu$ L	1200 $\mu$ L
✗	✗	✗	✗



**FULLY AUTOMATE WITH**  
Deepwell Microplate Domino  
186009597



**COLLECTION LABWARE**

Direct Compatibility - 24X Plate Formats  
PN: 176005201/-202

# Waters 10 mL 24-square well collection plate



**Manufacturer:**  
Waters Corporation

**Part number:**  
186005586



Compatible with  
Microplate  
Gripper

SEE THIS CONSUMABLE  
ON OUR E-SHOP



24X

## 1-channel pipettes

10 $\mu$ L	120 $\mu$ L	300 $\mu$ L	1000 $\mu$ L	5mL	10mL
✓	✓	✓	✓	✓	✓

## 8-channel pipettes

10 $\mu$ L	120 $\mu$ L	300 $\mu$ L	1200 $\mu$ L
✓	✓	✓	✓



FULLY AUTOMATE WITH  
Deepwell Microplate Domino  
186009597



COLLECTION LABWARE

Direct Compatibility - 24X Plate Formats  
PN: 176005201/-202

**EXTRACTION+**

WASTE & COLLECTION LABWARE

DIRECT COMPATIBILITY - 12X PLATE FORMATS

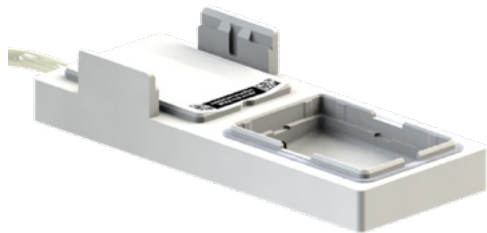

12X





**COLLECTION LABWARE**

Direct Compatibility - 12X Plate Formats  
PN: 176005201/-202

COMING SOON

**EXTRACTION+**

WASTE & COLLECTION LABWARE

DIRECT COMPATIBILITY - 8X PLATE FORMATS

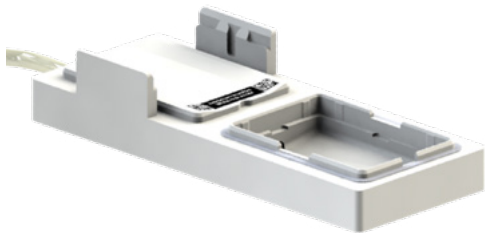



## **COLLECTION LABWARE**

Direct Compatibility - 8X Plate Formats  
PN: 176005201/-202

COMING SOON

**EXTRACTION+**

WASTE & COLLECTION LABWARE

DIRECT COMPATIBILITY - 1X PLATE FORMATS

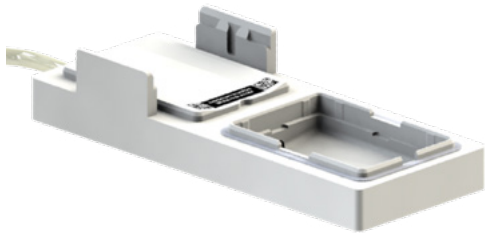

1X

# ArcticWhite, 290 mL single cavity reservoir



**Manufacturer:**  
ArcticWhite LLC

**Part number:**  
AWLS-S30017



1X

1-channel pipettes					
10 $\mu$ L	120 $\mu$ L	300 $\mu$ L	1000 $\mu$ L	5mL	10mL
✓	✓	✓	✓	✓	✓

8-channel pipettes			
10 $\mu$ L	120 $\mu$ L	300 $\mu$ L	1200 $\mu$ L
✓	✓	✓	✓



**FULLY AUTOMATE WITH**  
Deepwell Microplate Domino  
186009597



# Axygen® 96 V-bottom single well reservoir



**Manufacturer:**  
Corning Inc.

**Part number:**  
RES-SW96-HP-SI



1X

## 1-channel pipettes

10µL	120µL	300µL	1000µL	5mL	10mL
✓	✓	✓	✓	✓	✓

## 8-channel pipettes

10µL	120µL	300µL	1200µL
✓	✓	✓	✓



**FULLY AUTOMATE WITH**  
Deepwell Microplate Domino  
186009597

# EXTRACTION+

## WASTE & COLLECTION LABWARE

### COMPATIBILITY VIA 5ML TUBE COLLECTION RACK - 12X

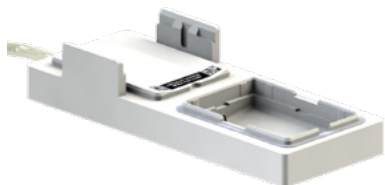

Ordering product number

**186010534**



12X

5mL Tube Collection Rack  
OneLab reference: [519.2651]

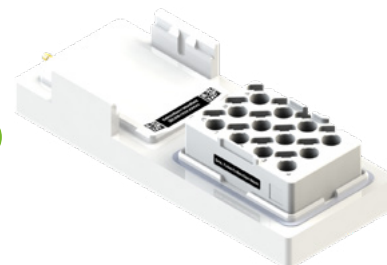

### IMPORTANT

For fully automated Extraction+ workflows involving the movements of collection labware via the 5mL Tube Collection Rack, ensure that you are equipped with both the Andrew+ Microplate Gripper Tool and the Collection Labware Rack Domino.

The 5mL Tube Collection Rack is a 12x (3x4) format Collection Rack. As of such, it is only compatible with 12x Extraction labware. Look out for the 12x compatibility symbol when selecting your Extraction Labware.

# VWR® 5 mL snap-cap centrifuge tube



**Manufacturer:**  
VWR International

**Part number:**  
10002-728

1-channel pipettes					
10µL	120µL	300µL	1000µL	5mL	10mL
✓	✓	✓	✓	✓	✓

8-channel pipettes			
10µL	120µL	300µL	1200µL
✗	✗	✗	✗



**FULLY AUTOMATE WITH**  
Collection Labware  
Rack Domino  
186010523



+



**COLLECTION LABWARE:**  
Compatibility via  
5mL Tube Collection Rack  
PN: 176005201/-202  
+ 186010534



# EXTRACTION+

## WASTE & COLLECTION LABWARE

### COMPATIBILITY VIA Ø12MM VIAL COLLECTION RACK - 24X

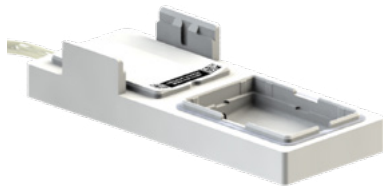

Ordering product number  
**186010531**



**24X**

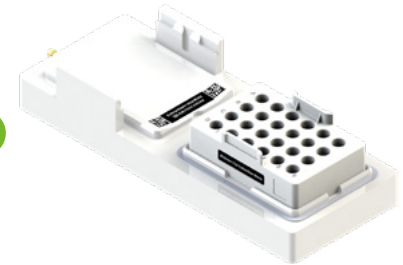

Ø12mm Vial Collection Rack

OneLab reference: [519.2601]



### IMPORTANT

For fully automated Extraction+ workflows involving the movements of collection labware via the Ø12mm Vial Collection Rack, ensure that you are equipped with both the Andrew+ Microplate Gripper Tool and the Collection Labware Rack Domino.

The Ø12mm Vial Collection Rack is a 24x (4x6) format Collection Rack. As of such, it is only compatible with 24x Extraction labware. Look out for the 24x compatibility symbol when selecting your Extraction Labware.

# Waters 2 mL 12x32 mm LC/GC screw-top vial, racked



**Manufacturer:**  
Waters Corporation

**Part number:**  
186000272C

SEE THIS CONSUMABLE  
ON OUR E-SHOP

## 1-channel pipettes

10µL	120µL	300µL	1000µL	5mL	10mL
✓	✓	✓	1 000	🧪	🧪

## 8-channel pipettes

10µL	120µL	300µL	1200µL
✗	✗	✗	✗

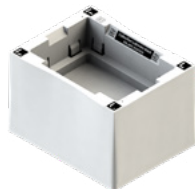

**FULLY AUTOMATE WITH**  
Collection Labware  
Rack Domino  
186010523



**COLLECTION LABWARE**  
Compatibility via ø12mm  
Vial Collection Rack – 24x  
PN: 176005201/-202  
+ PN: 186010531

# Waters 300 µL 12x32mm screw neck vial, racked



**Manufacturer:**  
Waters Corporation

**Part number:**  
186002639

SEE THIS CONSUMABLE  
ON OUR E-SHOP

1-channel pipettes					
10µL	120µL	300µL	1000µL	5mL	10mL
✓	✓	✓	150	🧪	🧪

8-channel pipettes			
10µL	120µL	300µL	1200µL
✗	✗	✗	✗

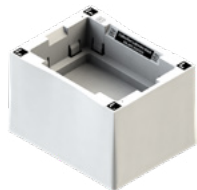

**FULLY AUTOMATE WITH**  
Collection Labware  
Rack Domino  
186010523

**COLLECTION LABWARE**  
Compatibility via ø12mm  
Vial Collection Rack – 24x  
PN: 176005201/-202  
+ PN: 186010531



# Waters 700 $\mu$ L 12x32mm screw neck vial, racked



**Manufacturer:**  
Waters Corporation

**Part number:**  
186005221

SEE THIS CONSUMABLE  
ON OUR E-SHOP

1-channel pipettes					
10 $\mu$ L	120 $\mu$ L	300 $\mu$ L	1000 $\mu$ L	5mL	10mL
✓	✓	✓	500	🧪	🧪

8-channel pipettes			
10 $\mu$ L	120 $\mu$ L	300 $\mu$ L	1200 $\mu$ L
✗	✗	✗	✗



**FULLY AUTOMATE WITH**  
Collection Labware  
Rack Domino  
186010523

**COLLECTION LABWARE**  
Compatibility via  $\varnothing$ 12mm  
Vial Collection Rack – 24x  
PN: 176005201/-202  
+ PN: 186010531



# Waters QuanRecovery™ 300 µL 12x32mm screw neck vial, racked



**Manufacturer:**  
Waters Corporation

**Part number:**  
186009186

SEE THIS CONSUMABLE  
ON OUR E-SHOP

1-channel pipettes					
10µL	120µL	300µL	1000µL	5mL	10mL
✓	✓	✓	150	🧪	🧪

8-channel pipettes			
10µL	120µL	300µL	1200µL
✗	✗	✗	✗



**FULLY AUTOMATE WITH**  
Collection Labware  
Rack Domino  
186010523



**COLLECTION LABWARE**  
Compatibility via ø12mm  
Vial Collection Rack – 24x  
PN: 176005201/-202  
+ PN: 186010531

# EXTRACTION+

## WASTE & COLLECTION LABWARE

### COMPATIBILITY VIA 4ML VIAL COLLECTION RACK - 24X

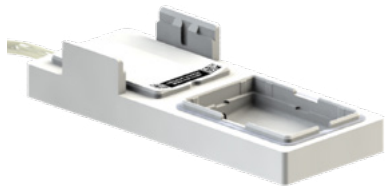

Ordering product number  
**18601193**



24X

4mL Vial Collection Rack  
OneLab reference: [519.2800]



### IMPORTANT

For fully automated Extraction+ workflows involving the movements of collection labware via the 4mL Vial Collection Rack, ensure that you are equipped with both the Andrew+ Microplate Gripper Tool and the Collection Labware Rack Domino.

The 4mL Tube Collection Rack is a 24x (4x6) format Collection Rack. As of such, it is only compatible with 24x Extraction labware. Look out for the 24x compatibility symbol when selecting your Extraction Labware.

# Clear Glass 4 mL Screw Neck Vial, racked



**Manufacturer:**  
Waters Corporation

**Part number:**  
186000840

SEE THIS CONSUMABLE  
ON OUR E-SHOP

1-channel pipettes					
10µL	120µL	300µL	1000µL	5mL	10mL
✓	✓	✓	✓	1 500	2 700

8-channel pipettes			
10µL	120µL	300µL	1200µL
✗	✗	✗	✗



**FULLY AUTOMATE WITH**  
Collection Labware  
Rack Domino  
186010523



**COLLECTION LABWARE**  
Compatibility via 4mL  
Vial Collection Rack  
PN: 176005201/-202  
+ PN: 186011193

# EXTRACTION+

## WASTE & COLLECTION LABWARE

### COMPATIBILITY VIA 10ML VIAL COLLECTION RACK - 8X

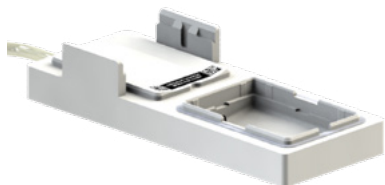

Ordering product number

**18611118**



**8X**

10mL Vial Collection Rack  
OneLab reference: [519.2771]

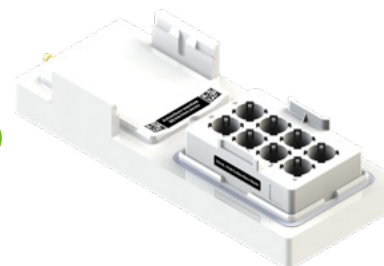

### IMPORTANT

For fully automated Extraction+ workflows involving the movements of collection labware via the 10mL Vial Collection Rack, ensure that you are equipped with both the Andrew+ Microplate Gripper Tool and the Collection Labware Rack Domino.

The 10mL Vial Collection Rack is a 8x (2x4) format Collection Rack. As of such, it is only compatible with 8x Extraction labware. Look out for the 8x compatibility symbol when selecting your Extraction Labware.



# WHEATON® 10 mL clear glass serum vial, racked



**Manufacturer:**  
DWK Life Sciences

**Part number:**  
223686

1-channel pipettes					
10µL	120µL	300µL	1000µL	5mL	10mL
✓	✓	✓	✓	✓	✓

8-channel pipettes			
10µL	120µL	300µL	1200µL
✗	✗	✗	✗



**FULLY AUTOMATE WITH**  
Collection Labware  
Rack Domino  
186010523



**COLLECTION LABWARE**  
Compatibility via 10mL  
Vial Collection Rack  
PN: 176005201/-202  
+ PN: 186111118