

Waters
THE SCIENCE OF
WHAT'S POSSIBLE.™

USER MANUAL

Extraction+

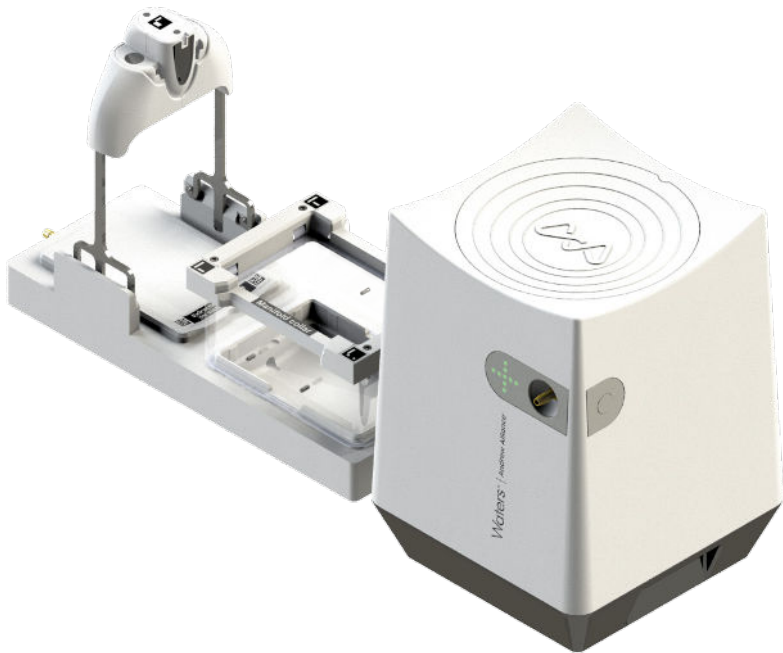

Safety instructions



- Do not use this device for:
 - evacuating biological habitats
 - evacuating explosive, corrosive, or similar gases
- The device is not suitable for:
 - inflating/deflating objects
 - pumping liquids
 - use in potentially explosive atmospheres
 - underwater usage
 - underground usage
- Set up the Extraction+ vacuum pump in a spacious area on an even, stable, clean, nonslip, dry surface.
- Completely switch off the device and remove cables before moving it.
- The user must maintain a distance of at least 20 cm from the product (WiFi antenna) during installation or operation.
- The device is intended for indoor use only.
- With the exception of filter cartridge replacement, device maintenance is exclusively reserved for Waters servicing and support representatives.
- If the device is used in any way other than those specified by the manufacturer, the user protection provided by the device may be impaired.
- The safety of the user cannot be ensured if modifications are made to the device or parts of the device by third parties.
- All input/output ports are Safety Extra Low Voltage (SELV) circuits. You should only connect SELV circuits to other SELV circuits.
- If the device overheats, it will stop operating. If this occurs, immediately disconnect the device from its power supply.

About this User Manual

Read the User Manual before using this device. Strictly follow usage and maintenance instructions provided. It is the user's responsibility to become familiar with all available information concerning the correct use, care, and limitations of these products. If you are uncertain about the correct use or limitations of the products, contact Waters service and support. The manufacturer, the distributor, and their respective owners, employees, agents, and representatives are not responsible or liable for errors or omissions.

Information in this User Manual is subject to change without notice and does not represent a commitment on the part of Waters. Waters assumes no responsibility for any inaccuracies that may be contained in this User Manual. Waters makes no commitment to update or keep current the information in this User Manual, and reserves the right to make improvements to this User Manual or to the products described herein at any time without notice.

If you find information in this manual that is incorrect, misleading, or incomplete, we would appreciate your comments and suggestions.

Product overview & setup

Extraction+ manifold

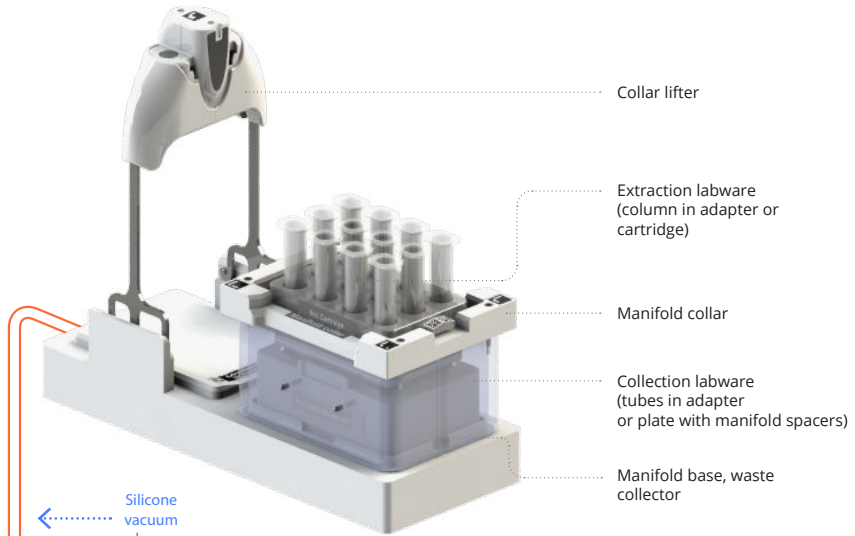

Extraction+ vacuum pump

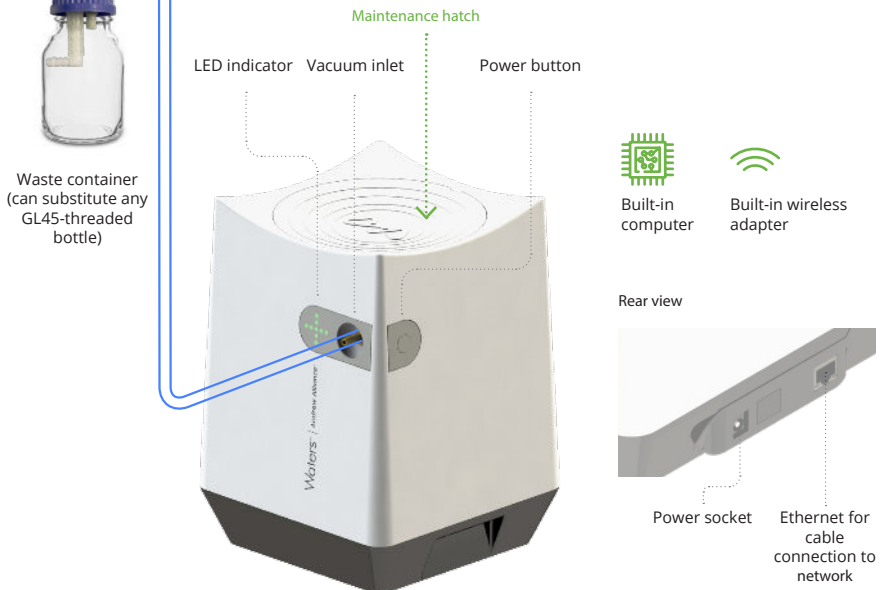

Getting started

A. Install the vacuum pump and liquid trap system

1 Place the Extraction+ vacuum pump

On or under the workbench, or on the floor.

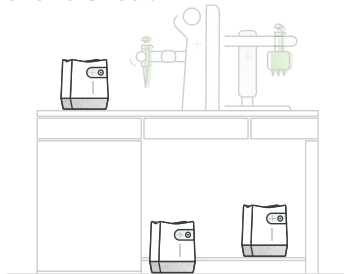

2 Place the waste container (GL45-threaded bottle)

On or under the workbench, or on the floor.



Bottle smaller than one liter can also be placed on the Extraction+ vacuum pump.

3 If needed, cut the silicone hoses to the appropriate lengths

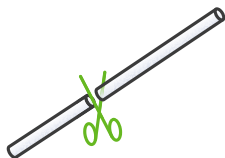

We recommend using the longest portion of the hose for connecting the Extraction+ vacuum pump to the waste container.



Ensure that the connection is loose enough to prevent the waste container from falling.

4 Connect the Extraction+ vacuum pump and the waste container using the silicone hose

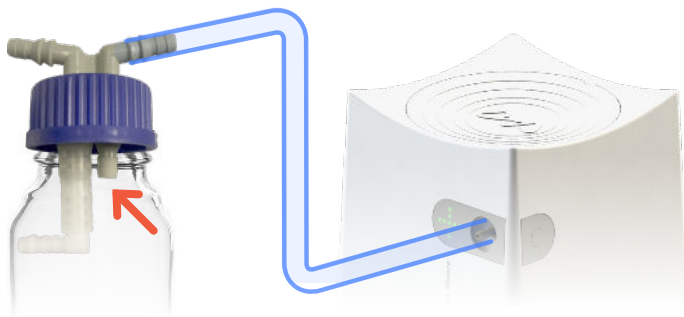

This hose must be connected to the shorter port of the thread.

B. Installation of the manifold

When used with the Andrew+ Pipetting Robot, the Extraction+ vacuum manifold is always placed at the same deck location:

Domino Location 5

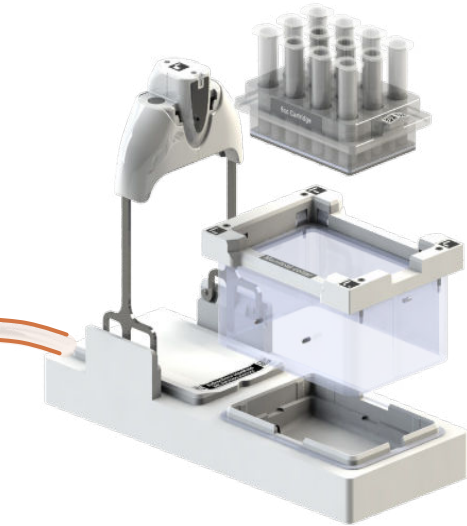

Setup for cartridge

- 1 Plug the **silicone hose** between the waste container and the Extraction+ manifold
This hose must be connected to the elbow port of the thread.
- 2 Place the manifold collar lifter
- 3 Place the manifold collar
- 4 Place the cartridge adapter as OneLab prompts you to

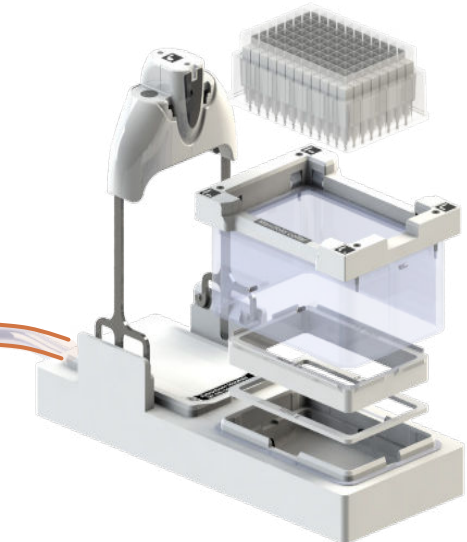
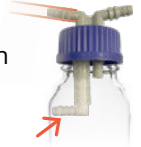

Setup for filter plate

- 1 Plug the **silicone hose** between the waste container and the Extraction+ manifold
This hose must be connected to the elbow port of the thread.
- 2 Place the manifold collar lifter
- 3 Place the **manifold spacers** into the waste collector (see additional instructions on the next page)
- 4 Place the manifold collar
- 5 Place the filter plate as OneLab prompts you to



B.1. Manifold spacers (only for use with filter plate)

The plate spacers allow fine-tuning of the penetration height of the filter plate tips within the wells of the collection labware. Ideal penetration is 2-3 mm.

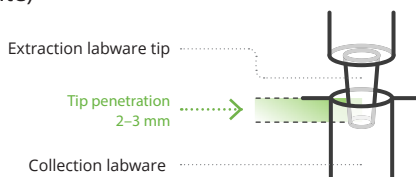

The spacer system is composed of three sizes:

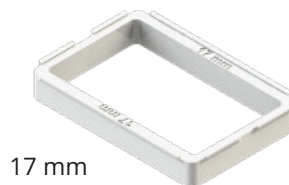
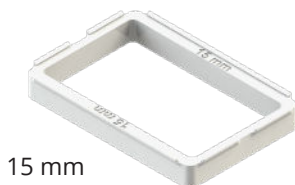

The spacers can be placed into the manifold waste collector...

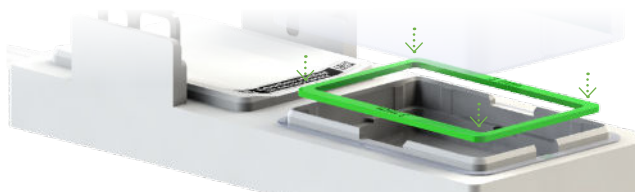

...and can be combined to further prop up collection plates if necessary (example here: 3 mm spacer + 15 mm spacer)

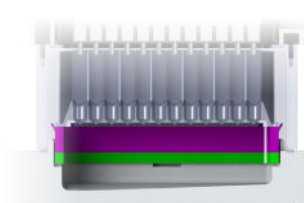
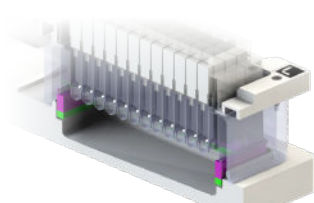

Examples of optimal spacer usage for different filter and collection consumable combinations

Collection consumable	Extraction plate skirt length	Size 1: Small skirt	Size 2: Long skirt
	Waters 2-mL 96-square well collection plate, cut corner H1		1 × 3 mm spacer
Waters 0.7-mL 96-round well collection plate		1 × 15 mm spacer	1 × 17 mm spacer on top of 1 × 15 mm spacer
Waters QuanRecovery™ 700-µL 96-well plate		1 × 15 mm spacer	1 × 17 mm spacer on top of 1 × 15 mm spacer
Waters 0.8-mL 96-round well collection plate		1 × 15 mm spacer	1 × 17 mm spacer on top of 1 × 15 mm spacer



Small skirt



Long skirt

B.2. Use of plate sealer (only for filter plate use)

To apply vacuum evenly on each filter plate cavity, we recommend placing a plate-sealer film on top of unused filter plate cavities.

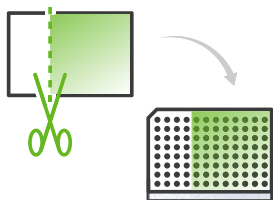

Cut off the desired dimensions and apply the film on the plate over the unused cavities



Sample available in the packaging

Ordering info: Adhesive Seal for 96-well and 384-well Plates, 100/pk, Waters p/n: 186006336C

Contact your Waters representative.

B.3. Use of sealing caps (only for cartridge use)

To apply vacuum evenly on each cartridge, we recommend placing sealing caps in each of the unused slots of the cartridge adapter.

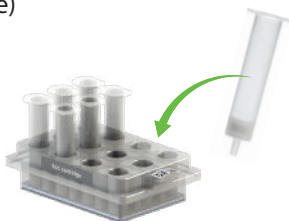

B.4. Collection labware rack (only for cartridge use)



When using cartridges as filter consumables during an automated run with the Andrew+ robot, OneLab prompts the usage of a Collection Labware Rack Domino in addition to the collection rack itself.

This Domino holds the collection consumables during the first phases of the solid-phase extraction, such as: conditioning, loading, and washing.

The Collection Labware Rack Domino is included in each Extraction+ Cartridge Kit. You can also purchase it separately.

B.5. Labware gripper (only for Andrew+ use)



Add the Microplate Gripper tool on the Andrew+ robot tool rack to ensure automated movement of collection labware and racks into and out of the manifold.

Ordering info: Microplate Gripper (Tool), Waters p/n: 186009776

Contact your Waters representative.

C. Connection to OneLab

Before
you begin

If you do not have a OneLab account, create one at:
<https://onelab.com/signup>

1 If you have a OneLab account, plug your Extraction+ vacuum pump into a power source.

The device will automatically start up.

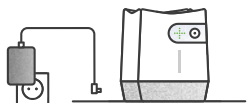

Only use the provided AC/DC power supply unit and cords.

2 Wait for the LED indicator to turn blue and blink.

After a couple of minutes, the Extraction+ vacuum pump will inform you when it is in installation mode.



If the Extraction+ vacuum pump does not automatically enter installation mode, press the power button five times.

3 Connect your computer, tablet, or smartphone to the Extraction+ vacuum pump.

A. Go to your WiFi settings and select the network named **Extraction-xxx.xxxx.xxxxx**.

xxxx.xxxxx is the Extraction+ device serial number (found on the back of the Extraction+ vacuum pump or on top of the Extraction+ vacuum manifold).



If you do not have access to a WiFi-compatible device, refer to our online Help: help.andrewalliance.com



B. The LED indicator stops blinking when the device is successfully connected.

4

Launch a Web browser, type <http://192.168.2.1>, and follow the on-screen steps to continue installation.



Note that the installation page might open automatically.

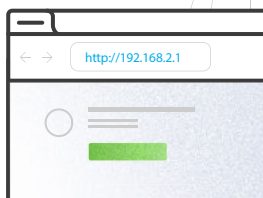

Feel free to contact
the Waters
support team



Chat with our support team
directly in OneLab



Send us an email at
aa_support@waters.com

We reply within one business day

Operations



Design your protocol

Our drag-n-drop editor makes it easy to design a precise and complete protocol with all you need to run your experiment perfectly.



Create a Flow-through extraction action by clicking this menu, which is located on the left side of the screen.

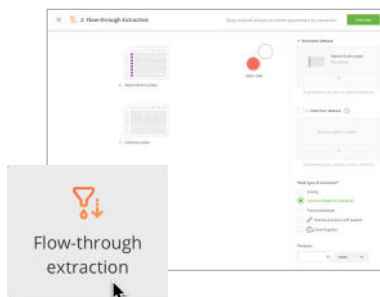

Execute experiment with Extraction+

OneLab automatically selects your Extraction+ and allows you to use it with each available experiment setup, manual, semi-automated, or fully automated operation.

Choose your desired experiment setup, and then prepare all the required materials.

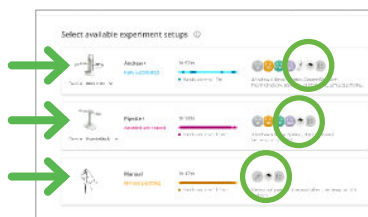

Start the experiment and let OneLab control your device

Follow the visual instructions based on the protocol you are using and you will be guided through your experiment.

Each step of the experiment is recorded and available in OneLab.



Technical data

Extraction+ pump

Maximum pump rate	13 L/min
Measurement range (absolute)	0–1030 mbar
Measurement accuracy TEB	25.9 mbar
Resolution	0.1 mbar
Minimum pressure at 370m	100 mbar
Compatible hose inner diameter	6 mm/1/4 inch
Relative humidity	80% at 37 °C
Maximum operating altitude	2000 m
Environment temperature operating range	+4 to +37 °C
Maximum noise	60 dB (A) at 1 m
User interface	Through OneLab software
Ingress protection	IP20*
Dimensions (W x L x H)	200 x 200 x 275 mm
Weight	3.7 kg
External power supply	Input 100–240 VAC, 1.4 A/output 24 VDC, 5 A, 120 W
Power or current rating	5 A
Overvoltage category DC port	Cat I
Operating voltage	24 VDC
Network connectivity	Gigabit Ethernet/WiFi 2.4 GHz and 5 GHz
Pollution degree of the intended environment	Pollution degree 2
Cleaning	Only with a wet tissue or isopropanol
Warranty	1 year
Certification	CE, FCC, RoHS, WEEE

Extraction+ manifold

Compatible labware	Refer to the OneLab Domino Catalog at andrewalliance.com/domino-catalog
Dimensions (W x L x H)	400 x 127 x 100 mm
Weight	1.5 kg
Compatible adapters and spacers	Refer to the OneLab Domino Catalog at andrewalliance.com/domino-catalog

*Avoid spilling liquid on the device.

Operating Extraction+ pump

Power on



When the device is in Standby (plugged in to a power source but turned off), press the power button to turn on the device.

Note: The device automatically starts up when you plug it in to a power source.

Power off



When the device is in its idle state (no ongoing experiment), press the power button for 5 seconds to turn it off.

Maintenance–Filter cartridge replacement



Open the maintenance hatch by pushing down the back of the hatch



Remove the hatch



Unplug the filter shell from the filter port



Unplug the small hose

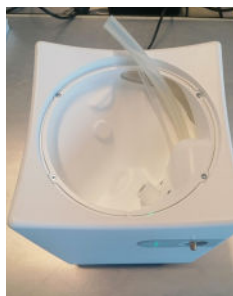

Unplug the big hose



Take a new filter, and plug in the big hose first



Plug in the small hose



Plug the filter in to the filter port



Place the filter inside the compartment



Push the small hose to straighten it



Replace the hatch

Unit end of life



When a unit reaches the end of its useful life, contact Waters for directions and information on the end-of-life policy.

This is in accordance with the European Union Directive 2002/96/EC on Waste Electrical and Electronic Equipment (WEEE).

Certifications

Electrical safety

- I. IEC 61010-1: 2010
- II. IEC 61010-1/A1: 2016
- III. UL 61010-1: 2012
- IV. CAN/CSA 22.2#61010-1-12

EMC

- I. EN 61326-1: 2013
- II. EN 301 489-1 V2.2.0
- III. EN 301 489-17 V3.1.0

RADIO

- I. EN 300 328 Ver 2.1.1
- II. EN 301 893 V2.1.1

FCC

- I. FCC 47 CFR part 15 subpart B section 15.107 (b) and section 15.109 (b and g) Class A all over other device tested per ANSI C63.4 (Ed. 2014) procedures
- II. This device complies with Part 15 of the FCC Rules. Operation is subject to the following two conditions:
(1) This device may not cause harmful interference, and (2) This device must accept any interference received, including interference that may cause undesired operation.

RoHS

RoHS 3 (EU) 2015/863

Andrew Alliance S.A.
Chemin Grenet 21
1214 Vernier (Geneve)
Switzerland

Waters Corp
34 Maple Street
Milford, MA 01757
USA

Phone: +41 22 518 0357

Phone: +1-508-478-2000

aa_contact@waters.com

